

## 65BAR10S TYNDBELP4A NSK

Axial angular contact ball bearing

TYPE: Ball bearings, Axial angular contact ball bearing, Single direction, Contact angle 30°, High speed, duplex, extra light preload (NSK)

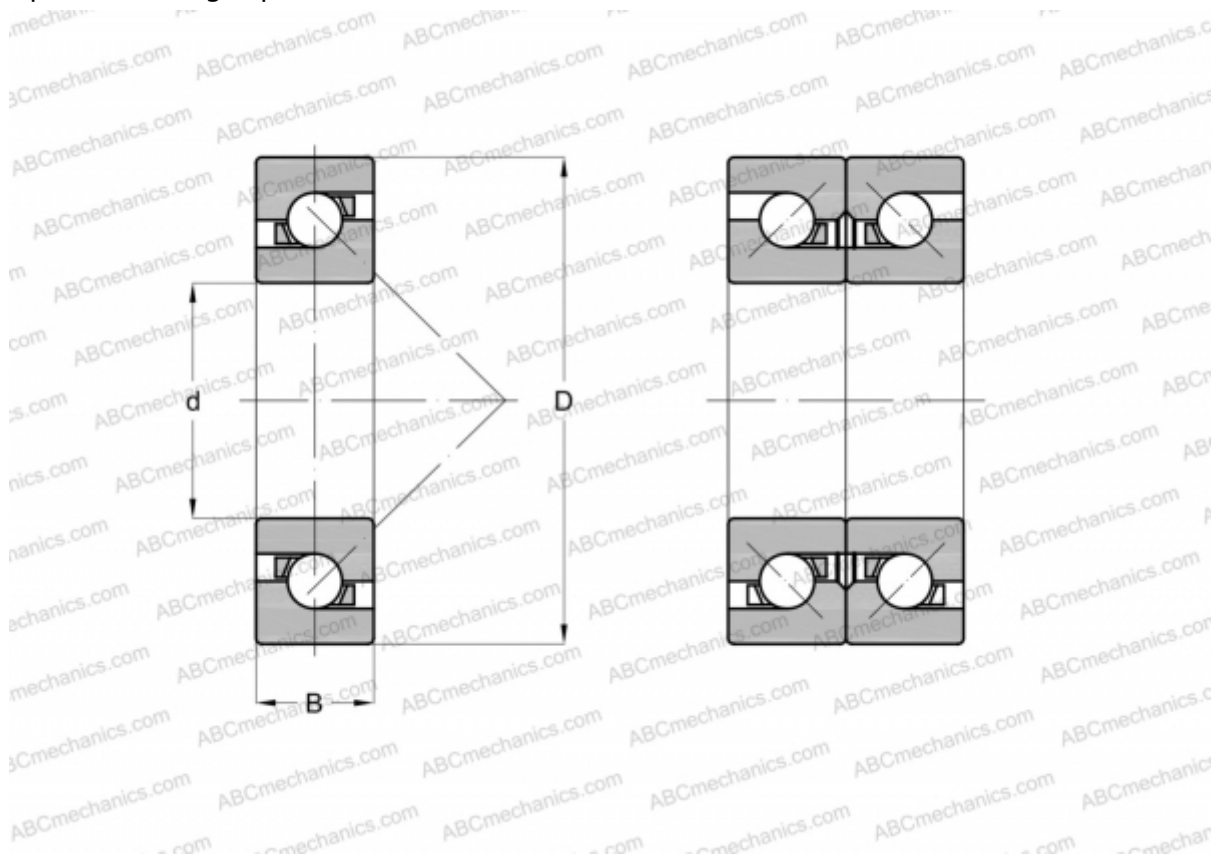

### Technical specification

#### DIMENSIONS, MM

d	65,000
D	100,000
B	16,500

**MANUFACTURER** [NSK](#)

#### CALCULATION DATA

Basic dynamic load rating, C	19,500 kN
Basic static load rating, Co	41,500 kN
Attainable speed for grease lubrication	9100 r/min
Attainable speed for oil-air lubrication	11600 r/min