

## 75BAR10S TYNDBELP4A NSK

Axial angular contact ball bearing

TYPE: Ball bearings, Axial angular contact ball bearing, Single direction, Contact angle 30°, High speed, duplex, extra light preload (NSK)

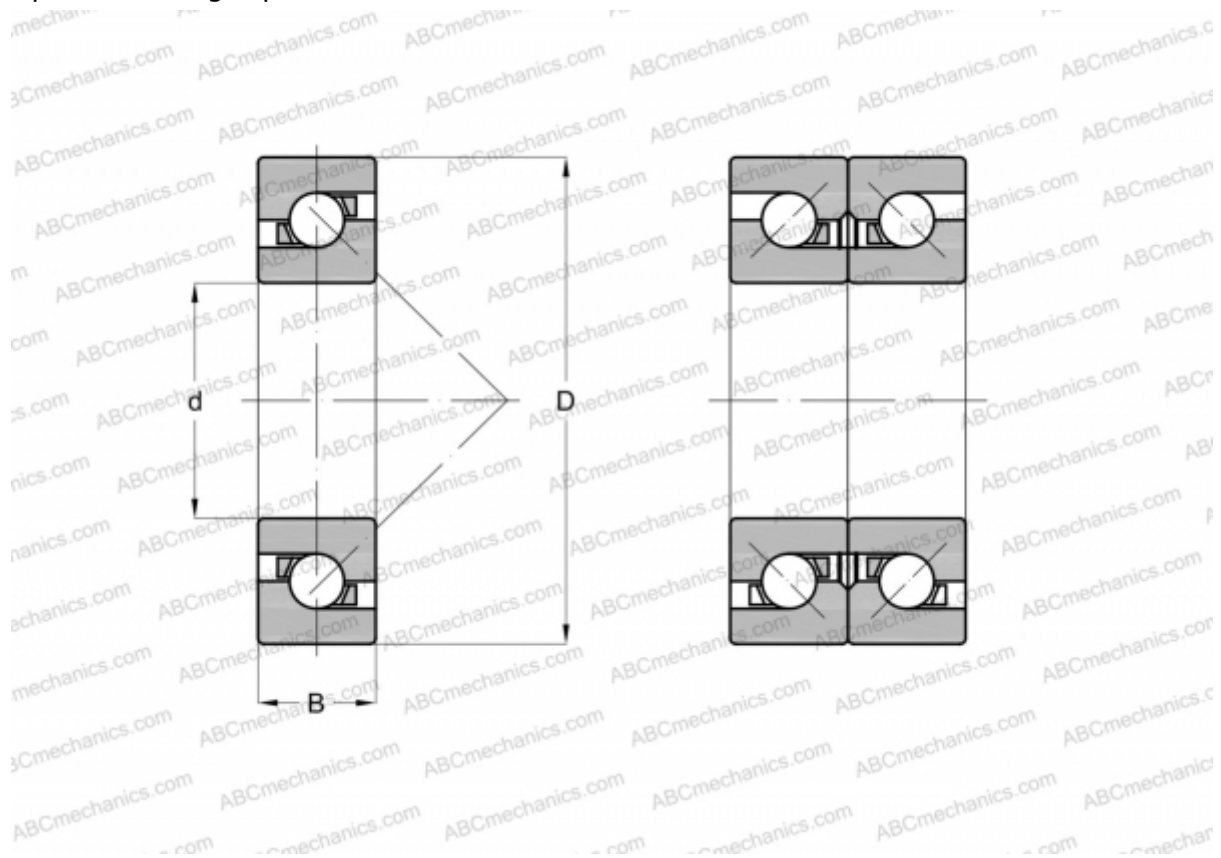

### Technical specification

#### DIMENSIONS, MM

d	75,000
D	115,000
B	18,000

**MANUFACTURER** [NSK](#)

#### CALCULATION DATA

Basic dynamic load rating, C	27,300 kN
Basic static load rating, Co	58,000 kN
Attainable speed for grease lubrication	7900 r/min
Attainable speed for oil-air lubrication	10000 r/min