

80BAR10S TYNDBELP4A NSK

Axial angular contact ball bearing

TYPE: Ball bearings, Axial angular contact ball bearing, Single direction, Contact angle 30°, High speed, duplex, extra light preload (NSK)

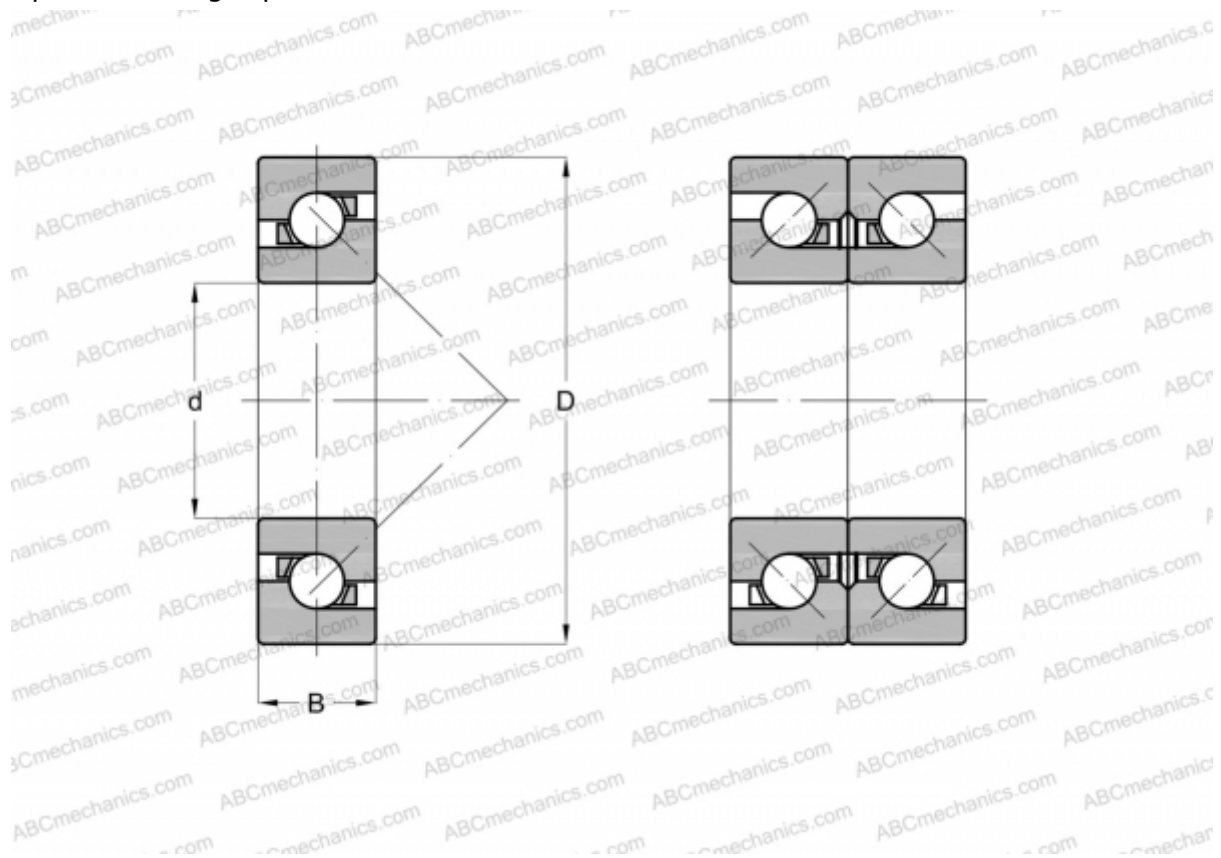

Technical specification

DIMENSIONS, MM

d	80,000
D	125,000
B	20,250

MANUFACTURER [NSK](#)

CALCULATION DATA

Basic dynamic load rating, C	32,000 kN
Basic static load rating, Co	68,500 kN
Attainable speed for grease lubrication	7400 r/min
Attainable speed for oil-air lubrication	9300 r/min