

## 90BAR10S TYNDBELP4A NSK

Axial angular contact ball bearing

TYPE: Ball bearings, Axial angular contact ball bearing, Single direction, Contact angle 30°, High speed, duplex, extra light preload (NSK)

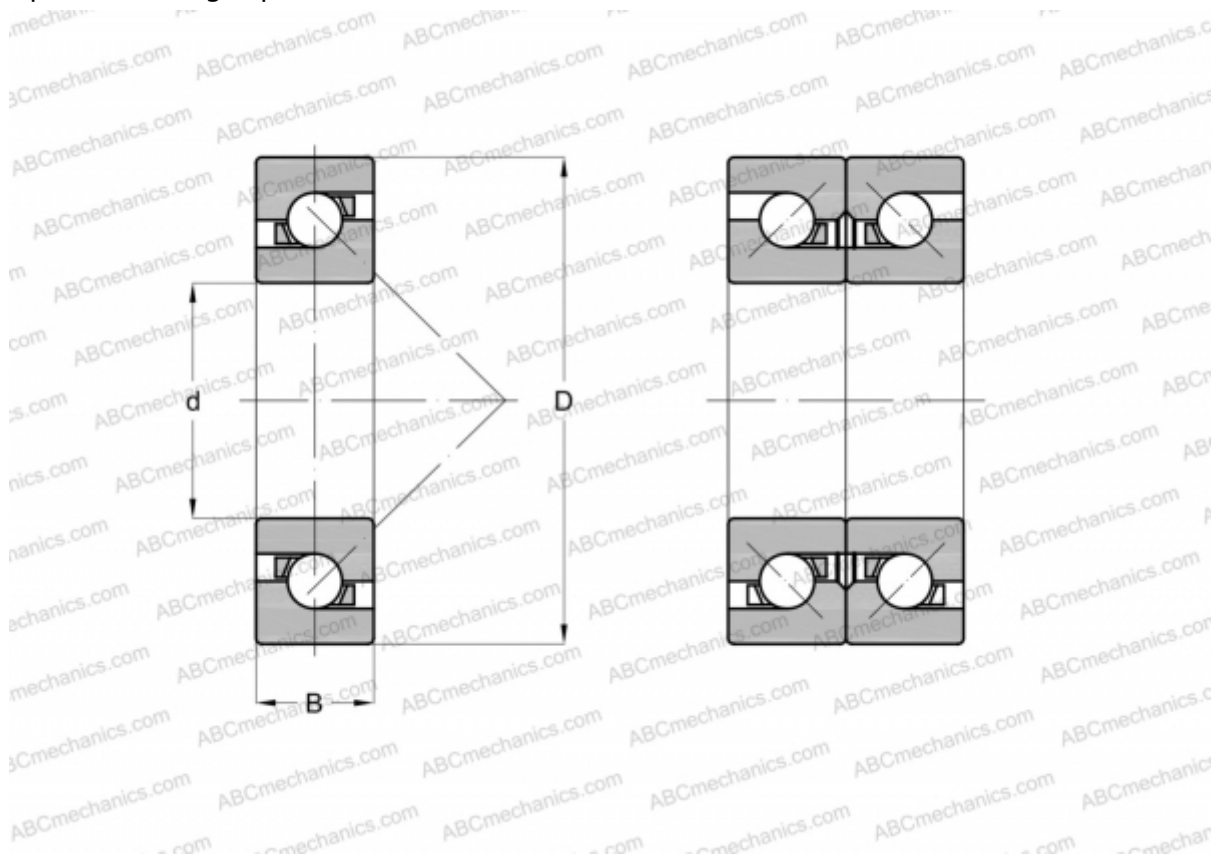

### Technical specification

#### DIMENSIONS, MM

d	90,000
D	140,000
B	22,500

**MANUFACTURER** [NSK](#)

#### CALCULATION DATA

Basic dynamic load rating, C	42,500 kN
Basic static load rating, Co	92,500 kN
Attainable speed for grease lubrication	6600 r/min
Attainable speed for oil-air lubrication	8300 r/min