

## 60BAR10H TYNDBLP4A NSK

Axial angular contact ball bearing

TYPE: Ball bearings, Axial angular contact ball bearing, Single direction, Contact angle 30°, High speed, ceramic ball, duplex, light preload (NSK)

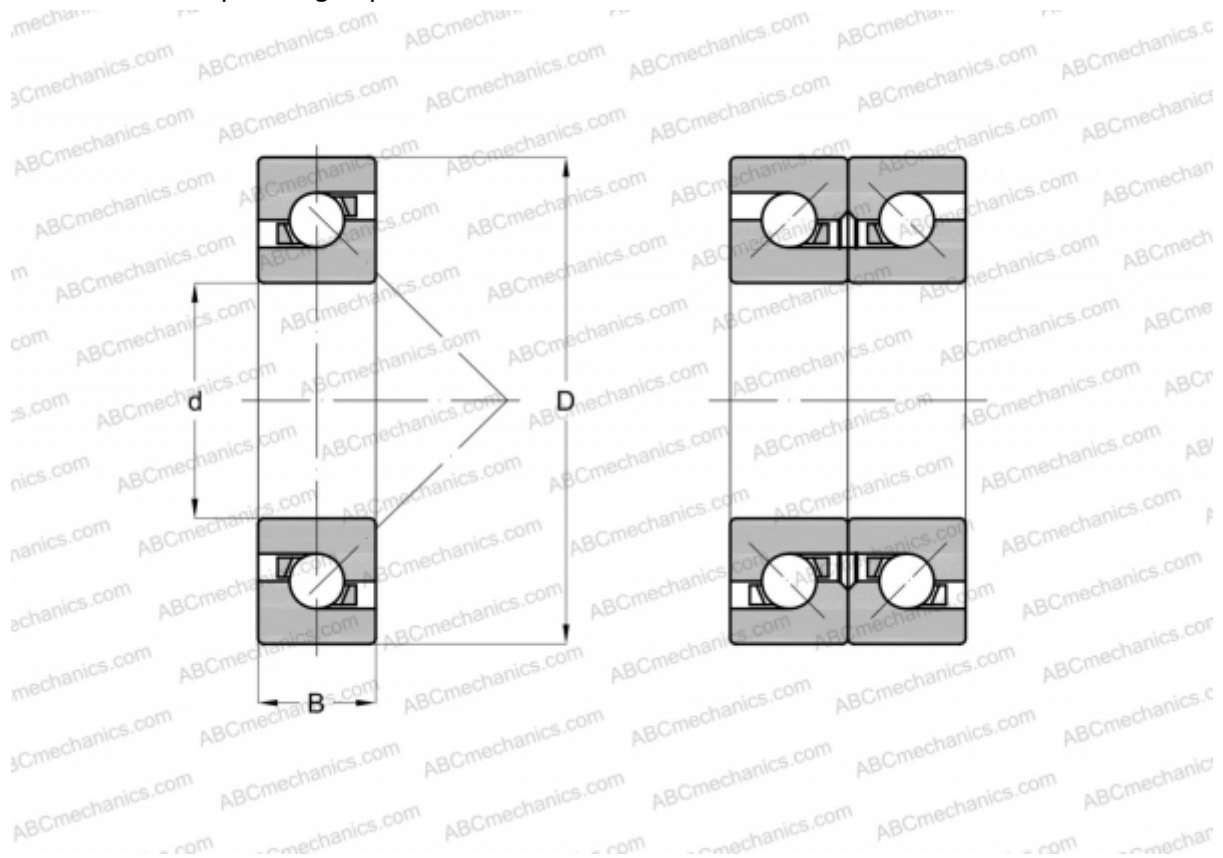

### Technical specification

#### DIMENSIONS, MM

$d$	60,000
$D$	95,000
$B$	16,500

**MANUFACTURER** [NSK](#)

#### CALCULATION DATA

Basic dynamic load rating, $C$	18,900 kN
Basic static load rating, $C_0$	38,000 kN
Attainable speed for grease lubrication	11000 r/min
Attainable speed for oil-air lubrication	13600 r/min