

## 80BAR10H TYNDBLP4A NSK

Axial angular contact ball bearing

TYPE: Ball bearings, Axial angular contact ball bearing, Single direction, Contact angle 30°, High speed, ceramic ball, duplex, light preload (NSK)

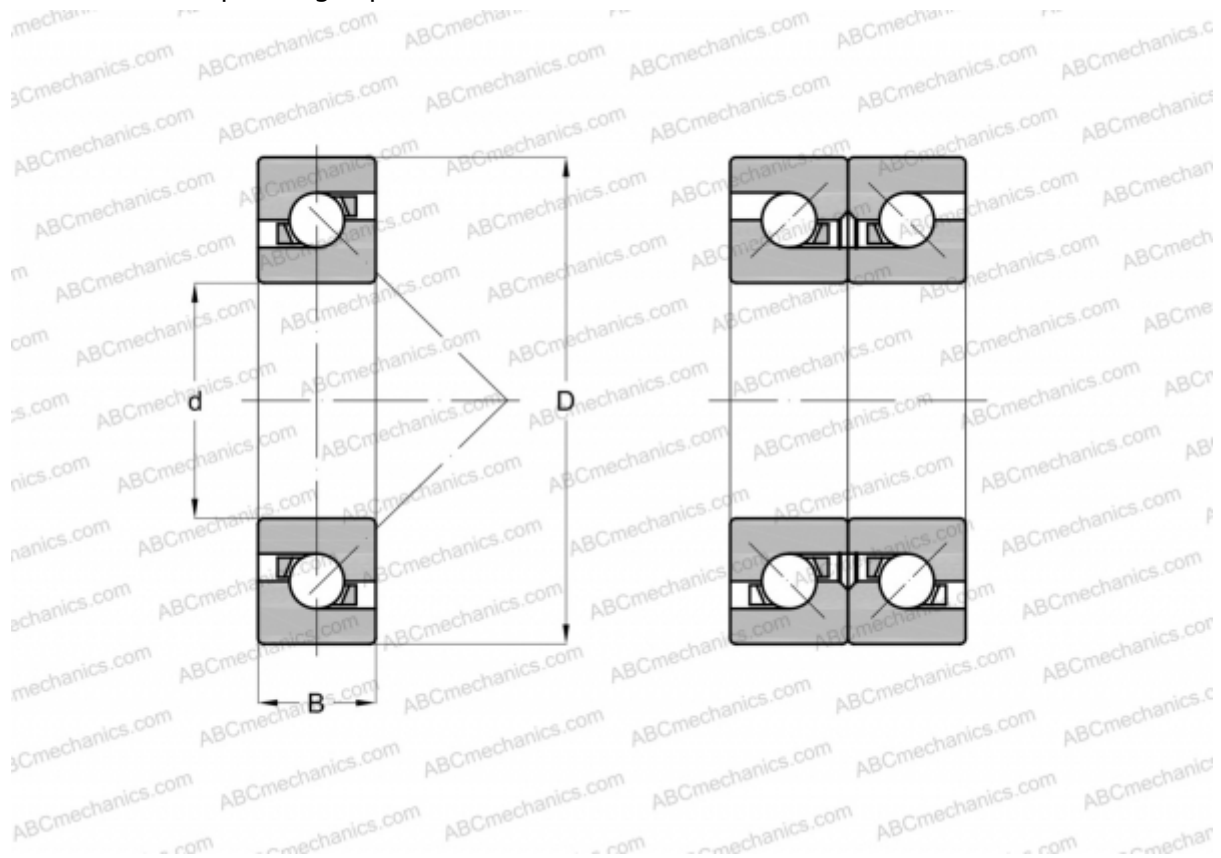

### Technical specification

#### DIMENSIONS, MM

d	80,000
D	125,000
B	20,250

**MANUFACTURER** [NSK](#)

#### CALCULATION DATA

Basic dynamic load rating, C	32,000 kN
Basic static load rating, Co	68,500 kN
Attainable speed for grease lubrication	8300 r/min
Attainable speed for oil-air lubrication	10300 r/min