

90BAR10H TYNDBLP4A NSK

Axial angular contact ball bearing

TYPE: Ball bearings, Axial angular contact ball bearing, Single direction, Contact angle 30°, High speed, ceramic ball, duplex, light preload (NSK)

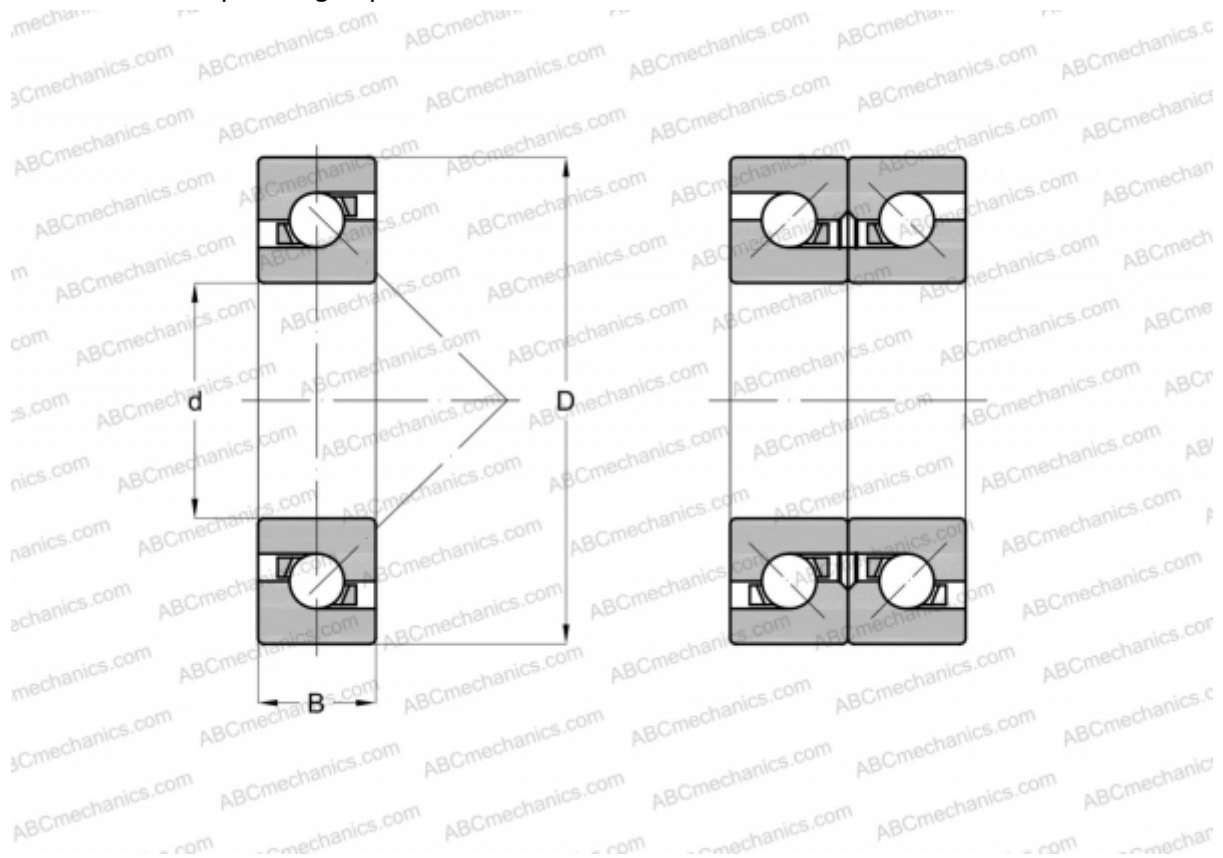

Technical specification

DIMENSIONS, MM

d	90,000
D	140,000
B	22,500

MANUFACTURER [NSK](#)

CALCULATION DATA

Basic dynamic load rating, C	42,500 kN
Basic static load rating, Co	92,500 kN
Attainable speed for grease lubrication	7400 r/min
Attainable speed for oil-air lubrication	9200 r/min