

## 95BAR10H TYNDBLP4A NSK

Axial angular contact ball bearing

TYPE: Ball bearings, Axial angular contact ball bearing, Single direction, Contact angle 30°, High speed, ceramic ball, duplex, light preload (NSK)

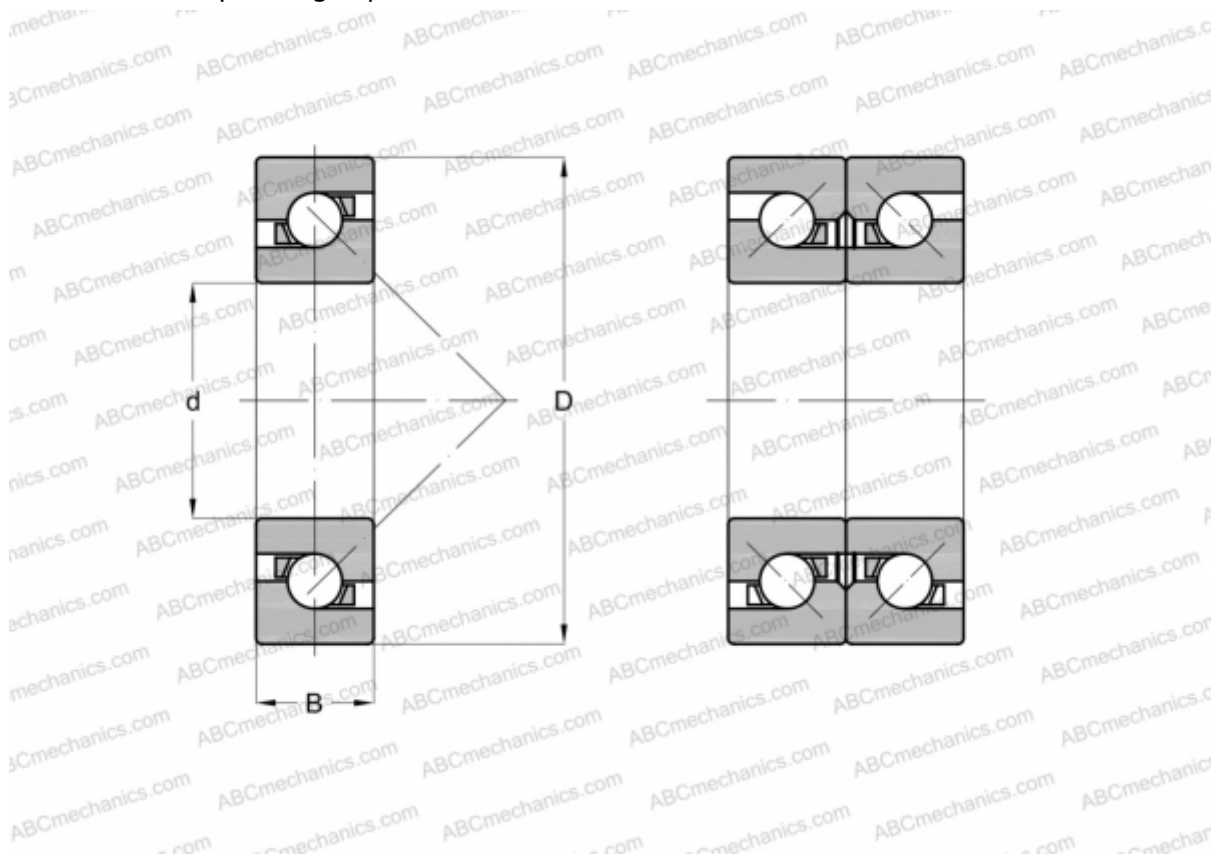

### Technical specification

#### DIMENSIONS, MM

d	95,000
D	145,000
B	22,500

**MANUFACTURER** [NSK](#)

#### CALCULATION DATA

Basic dynamic load rating, C	43,000 kN
Basic static load rating, Co	96,500 kN
Attainable speed for grease lubrication	7100 r/min
Attainable speed for oil-air lubrication	8800 r/min