

50BAR10H TYNDBELP4A NSK

Axial angular contact ball bearing

TYPE: Ball bearings, Axial angular contact ball bearing, Single direction, Contact angle 30°, High speed, duplex, ceramic ball, extra light preload (NSK)

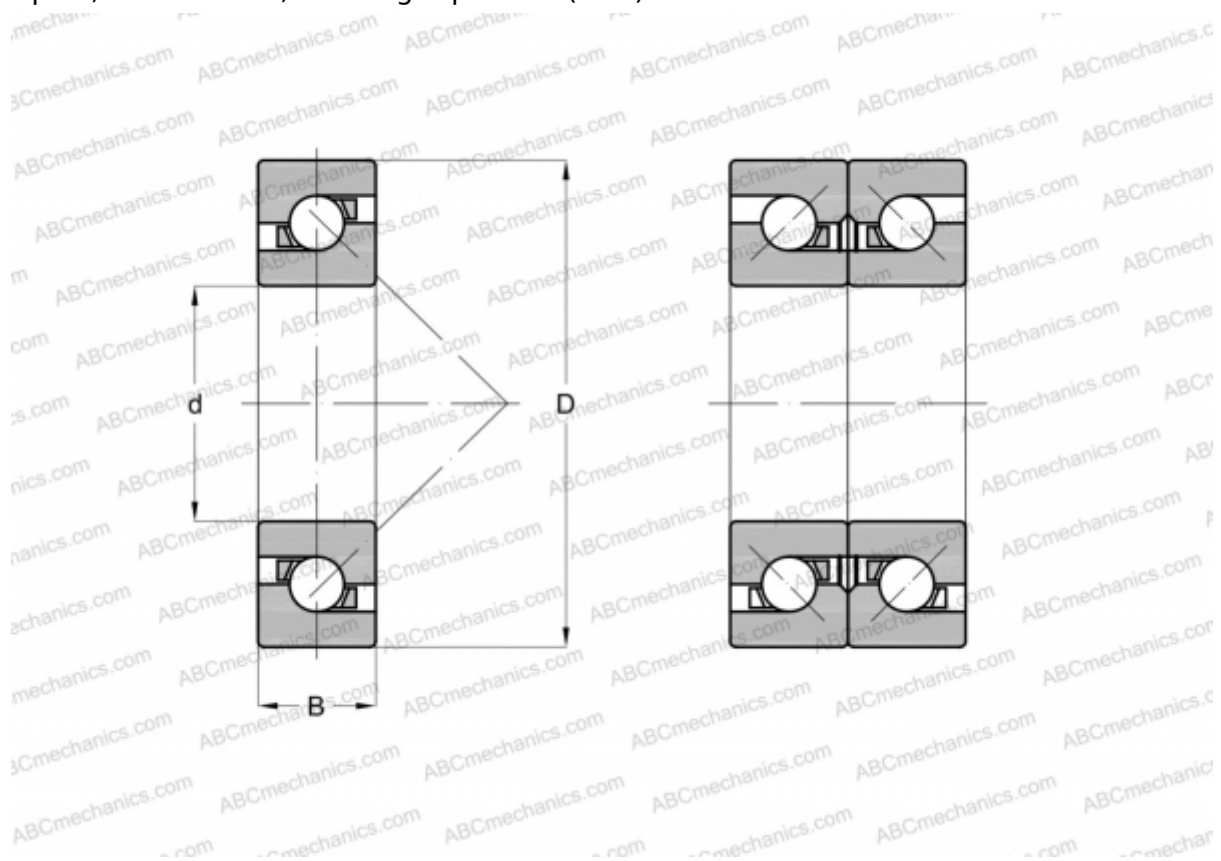

Technical specification

DIMENSIONS, MM

d	50,000
D	80,000
B	14,250

MANUFACTURER [NSK](#)

CALCULATION DATA

Basic dynamic load rating, C	14,700 kN
Basic static load rating, Co	27,700 kN
Attainable speed for grease lubrication	13100 r/min
Attainable speed for oil-air lubrication	16200 r/min