

70BAR10H TYNDBELP4A NSK

Axial angular contact ball bearing

TYPE: Ball bearings, Axial angular contact ball bearing, Single direction, Contact angle 30°, High speed, duplex, ceramic ball, extra light preload (NSK)

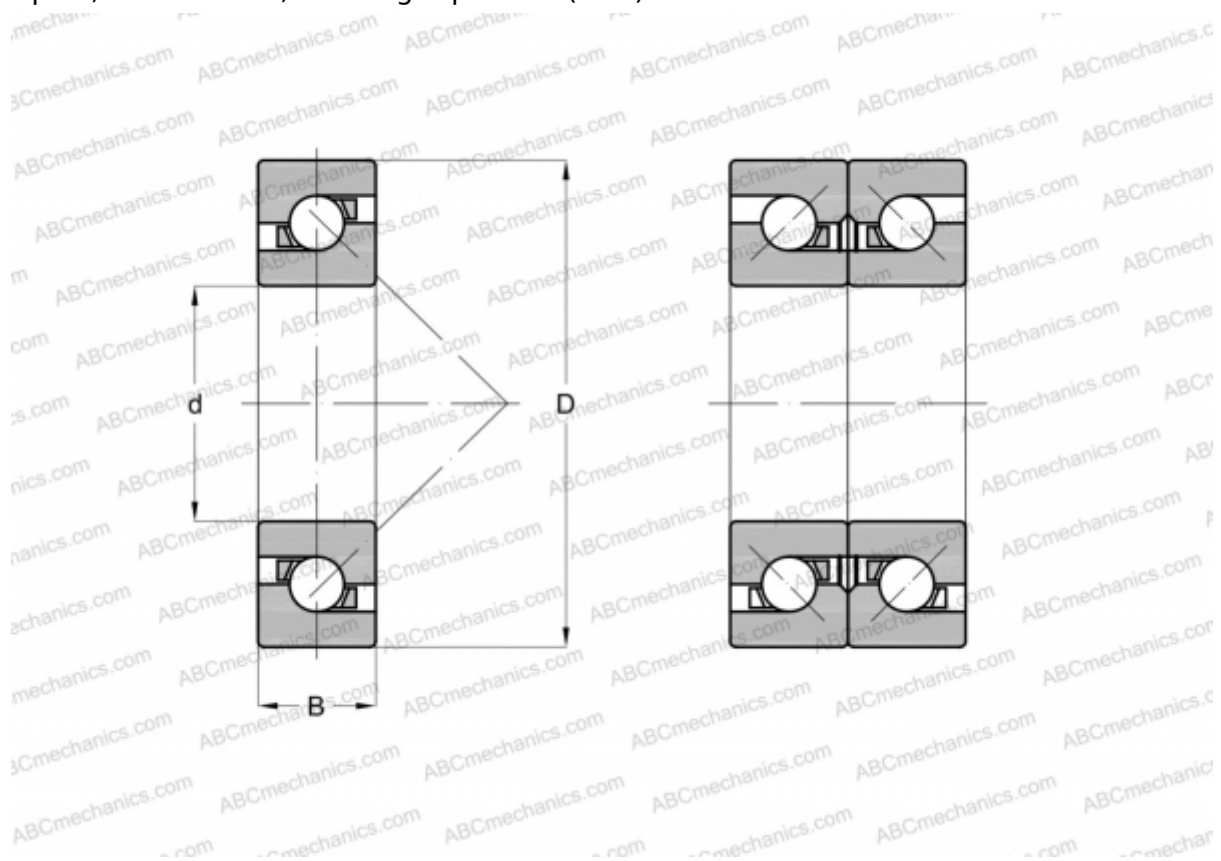

Technical specification

DIMENSIONS, MM

d	70,000
D	110,000
B	18,000

MANUFACTURER [NSK](#)

CALCULATION DATA

Basic dynamic load rating, C	26,900 kN
Basic static load rating, Co	55,000 kN
Attainable speed for grease lubrication	9500 r/min
Attainable speed for oil-air lubrication	11700 r/min