

## 60BTR10S TYNDBLP4A NSK

Axial angular contact ball bearing

TYPE: Ball bearings, Axial angular contact ball bearing, Single direction, Contact angle 40°, High speed, duplex, light preload (NSK)

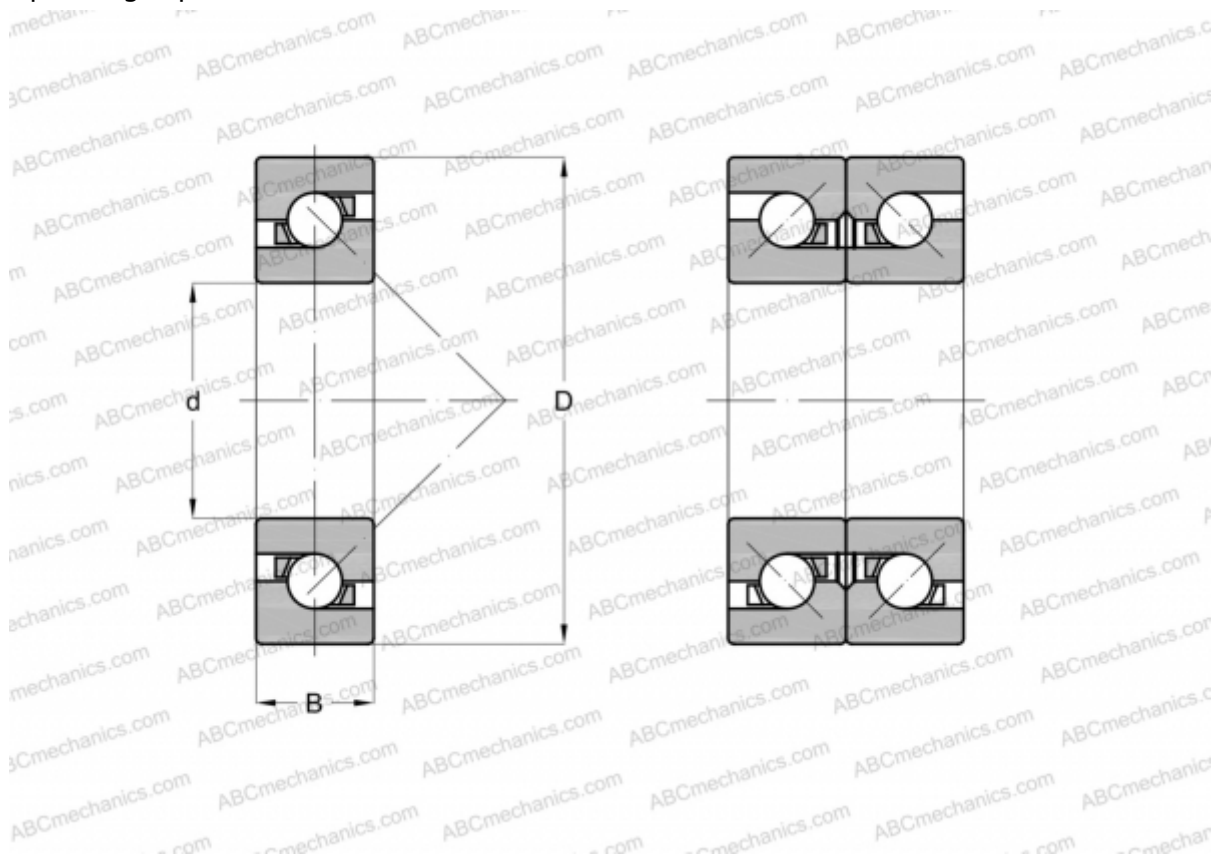

### Technical specification

#### DIMENSIONS, MM

d	60,000
D	95,000
B	16,500

**MANUFACTURER** [NSK](#)

#### CALCULATION DATA

Basic dynamic load rating, C	22,400 kN
Basic static load rating, Co	43,500 kN
Attainable speed for grease lubrication	8400 r/min
Attainable speed for oil-air lubrication	11000 r/min