

## 65BTR10S TYNDBLP4A NSK

Axial angular contact ball bearing

TYPE: Ball bearings, Axial angular contact ball bearing, Single direction, Contact angle 40°, High speed, duplex, light preload (NSK)

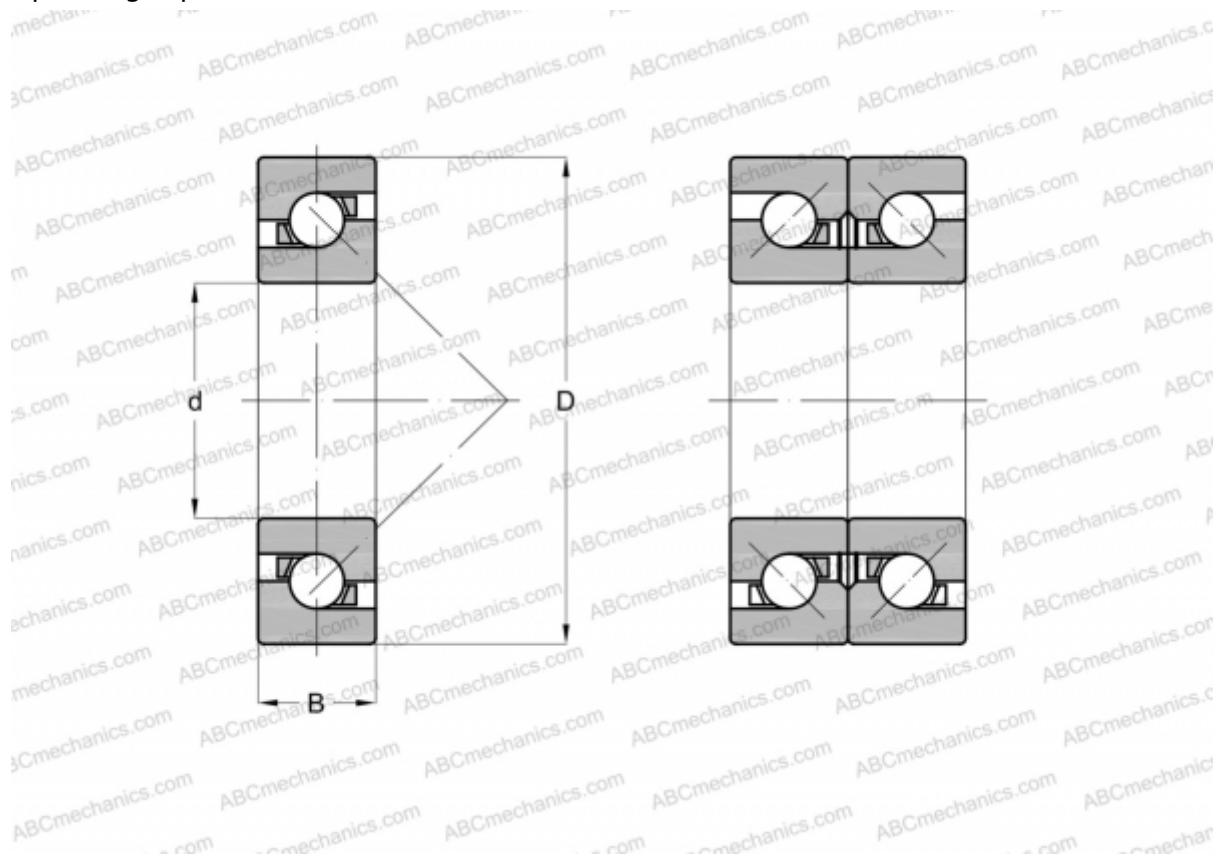

### Technical specification

#### DIMENSIONS, MM

d	65,000
D	100,000
B	16,500

**MANUFACTURER** [NSK](#)

#### CALCULATION DATA

Basic dynamic load rating, C	23,100 kN
Basic static load rating, Co	47,000 kN
Attainable speed for grease lubrication	7900 r/min
Attainable speed for oil-air lubrication	10400 r/min