

## 90BTR10S TYNDBELP4A NSK

Axial angular contact ball bearing

TYPE: Ball bearings, Axial angular contact ball bearing, Single direction, Contact angle 40°, High speed, duplex, extra light preload (NSK)

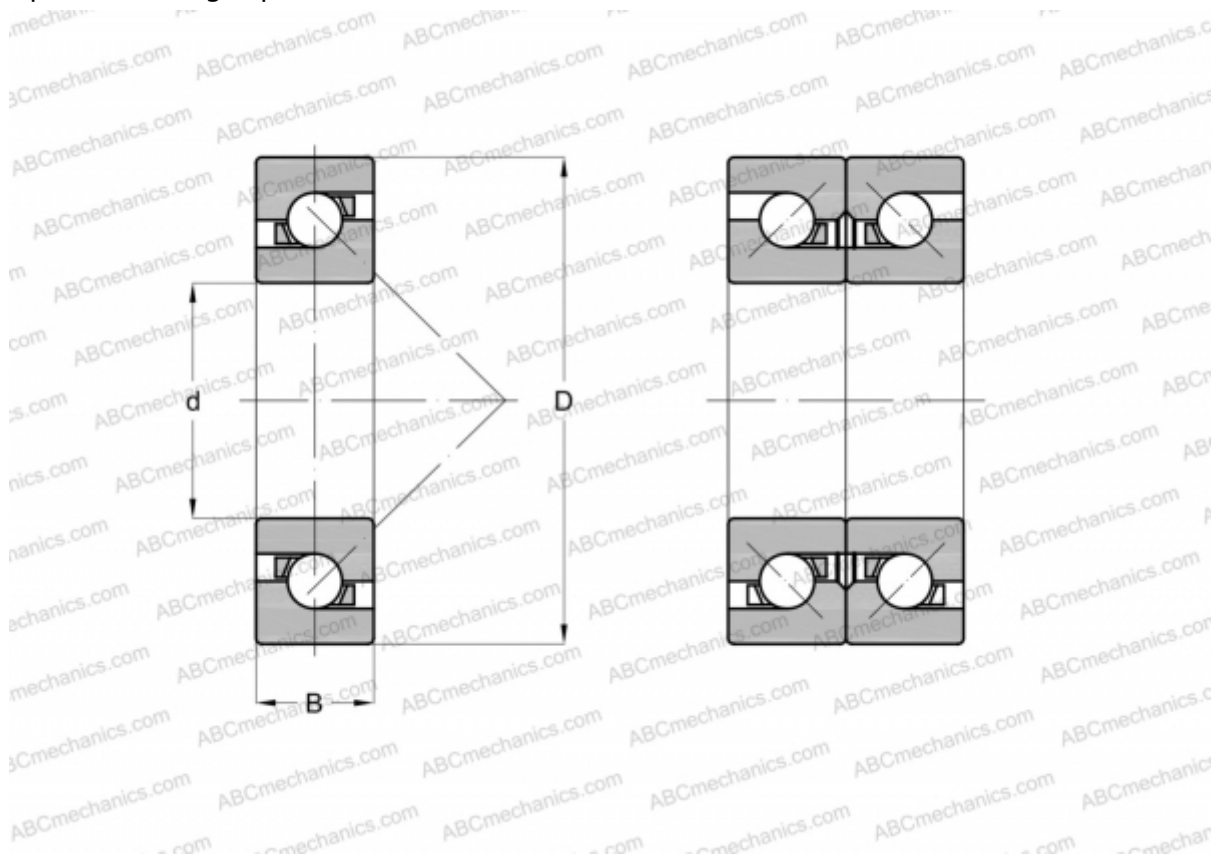

### Technical specification

#### DIMENSIONS, MM

d	90,000
D	140,000
B	22,500

**MANUFACTURER** [NSK](#)

#### CALCULATION DATA

Basic dynamic load rating, C	50,000 kN
Basic static load rating, Co	105,000 kN
Attainable speed for grease lubrication	5700 r/min
Attainable speed for oil-air lubrication	7400 r/min