

95BTR10S TYNDBELP4A NSK

Axial angular contact ball bearing

TYPE: Ball bearings, Axial angular contact ball bearing, Single direction, Contact angle 40°, High speed, duplex, extra light preload (NSK)

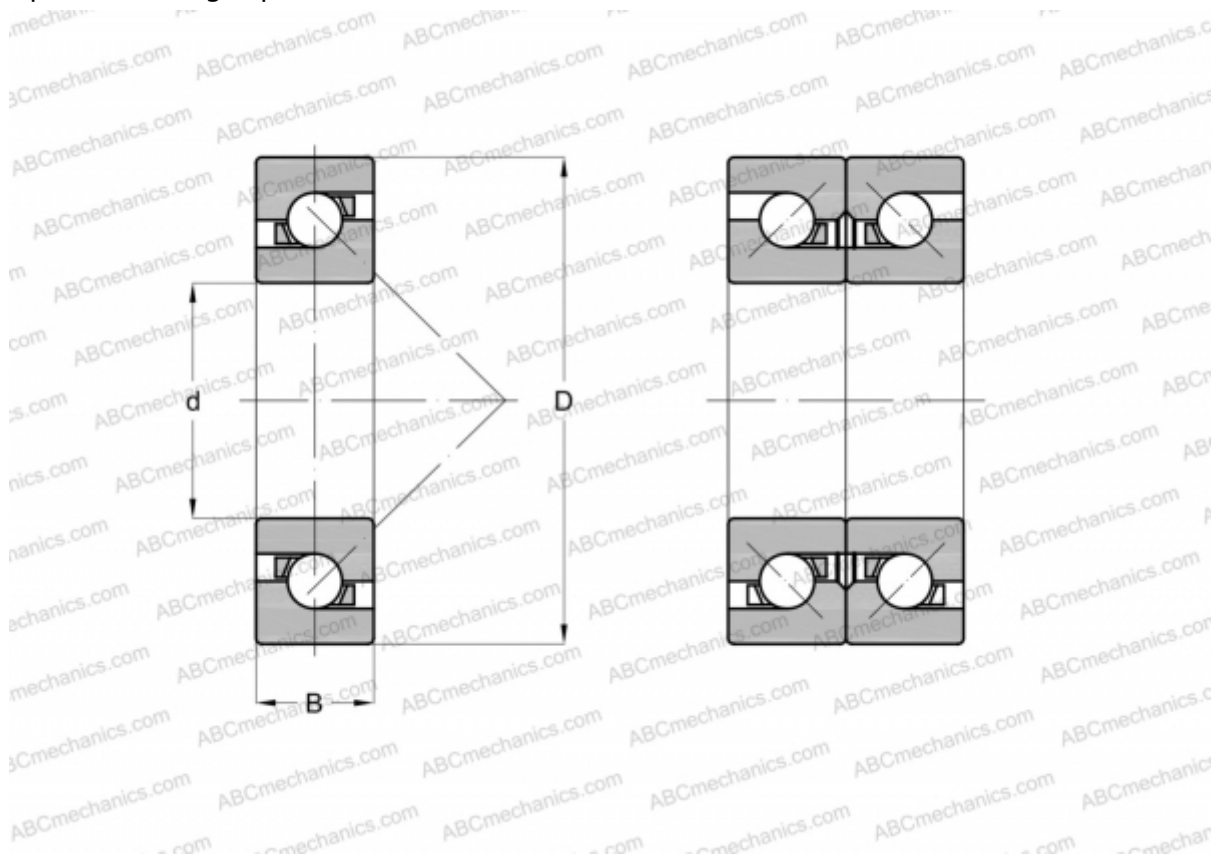

Technical specification

DIMENSIONS, MM

d	95,000
D	145,000
B	22,500

MANUFACTURER [NSK](#)

CALCULATION DATA

Basic dynamic load rating, C	51,000 kN
Basic static load rating, Co	110,000 kN
Attainable speed for grease lubrication	5500 r/min
Attainable speed for oil-air lubrication	7100 r/min