

65BTR10H TYNDBLP4A NSK

Axial angular contact ball bearing

TYPE: Ball bearings, Axial angular contact ball bearing, Single direction, Contact angle 40°, High speed, ceramic ball, duplex, light preload (NSK)

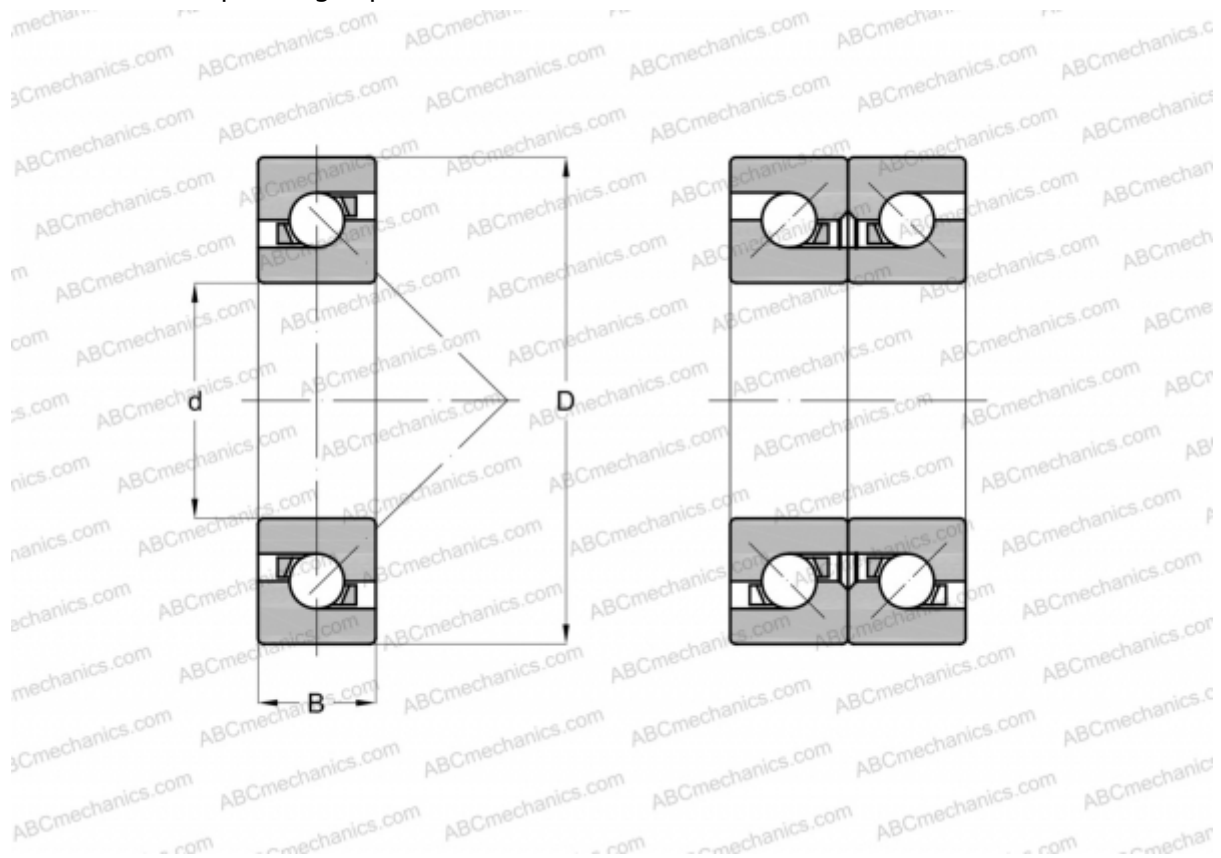

Technical specification

DIMENSIONS, MM

d	65,000
D	100,000
B	16,500

MANUFACTURER [NSK](#)

CALCULATION DATA

Basic dynamic load rating, C	23,100 kN
Basic static load rating, Co	47,000 kN
Attainable speed for grease lubrication	9100 r/min
Attainable speed for oil-air lubrication	11600 r/min