

80BTR10H TYNDBLP4A NSK

Axial angular contact ball bearing

TYPE: Ball bearings, Axial angular contact ball bearing, Single direction, Contact angle 40°, High speed, ceramic ball, duplex, light preload (NSK)

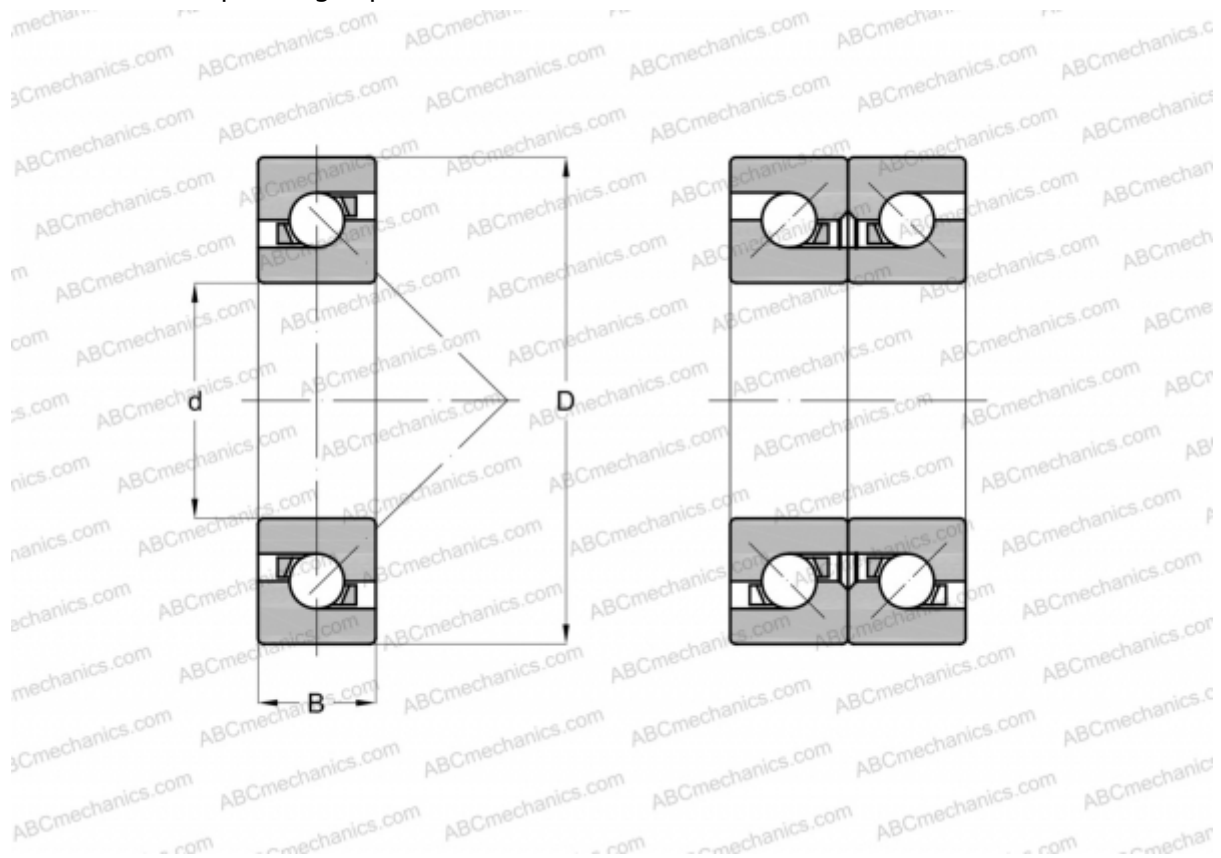

Technical specification

DIMENSIONS, MM

d	80,000
D	125,000
B	20,250

MANUFACTURER [NSK](#)

CALCULATION DATA

Basic dynamic load rating, C	38,000 kN
Basic static load rating, C_0	78,000 kN
Attainable speed for grease lubrication	7400 r/min
Attainable speed for oil-air lubrication	9300 r/min