

70BTR10H TYNDBELP4A NSK

Axial angular contact ball bearing

TYPE: Ball bearings, Axial angular contact ball bearing, Single direction, Contact angle 40°, High speed, duplex, ceramic ball, extra light preload (NSK)

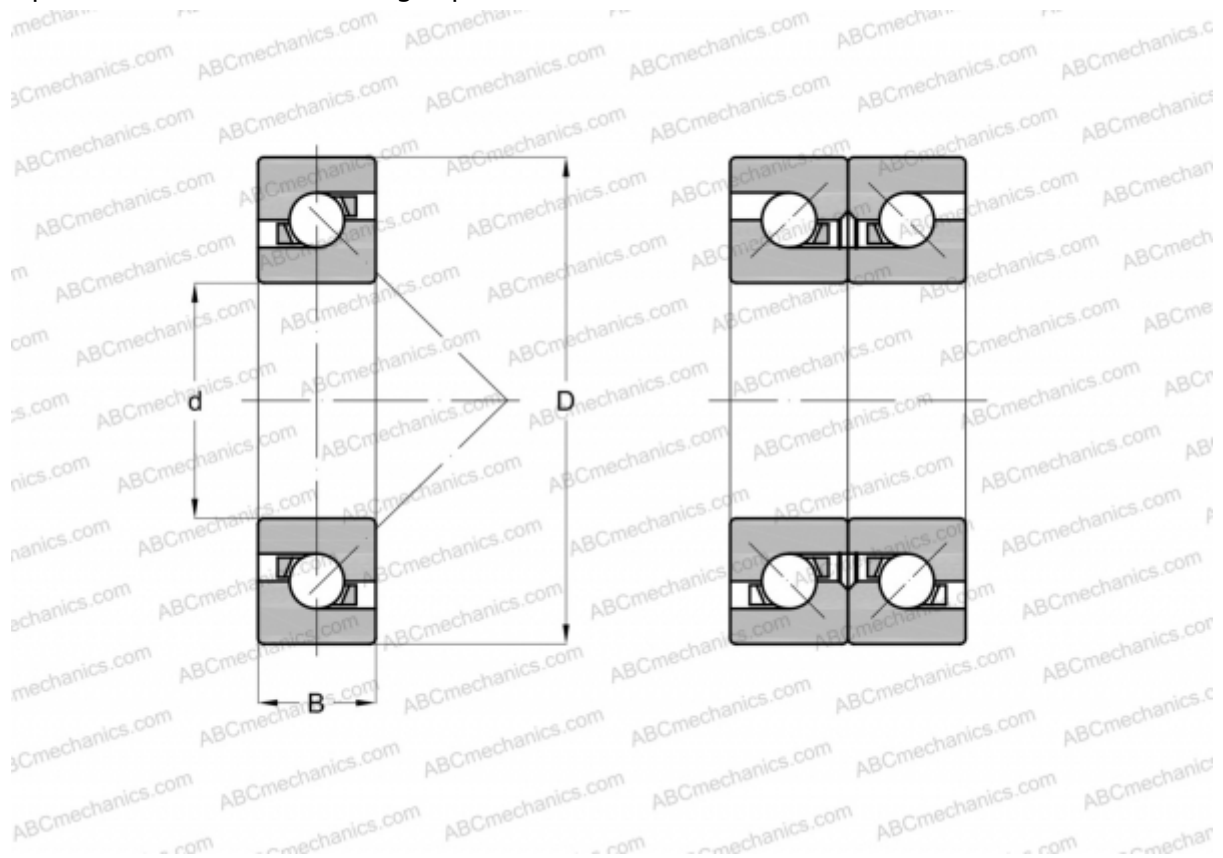

Technical specification

DIMENSIONS, MM

d	70,000
D	110,000
B	18,000

MANUFACTURER [NSK](#)

CALCULATION DATA

Basic dynamic load rating, C	32,000 kN
Basic static load rating, Co	63,000 kN
Attainable speed for grease lubrication	8400 r/min
Attainable speed for oil-air lubrication	10600 r/min