

## 80BTR10H TYNDBELP4A NSK

Axial angular contact ball bearing

TYPE: Ball bearings, Axial angular contact ball bearing, Single direction, Contact angle 40°, High speed, duplex, ceramic ball, extra light preload (NSK)

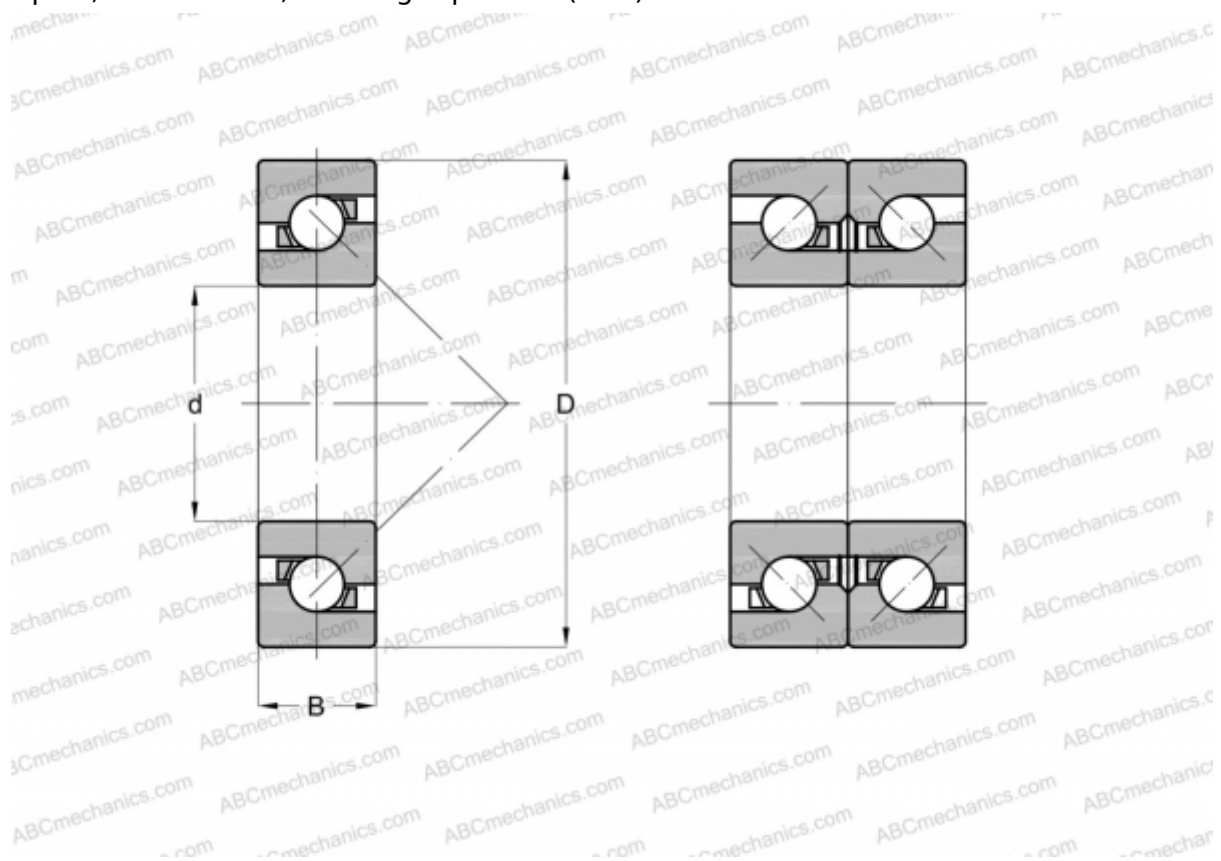

### Technical specification

#### DIMENSIONS, MM

d	80,000
D	125,000
B	20,250

**MANUFACTURER** [NSK](#)

#### CALCULATION DATA

Basic dynamic load rating, C	38,000 kN
Basic static load rating, Co	78,000 kN
Attainable speed for grease lubrication	7400 r/min
Attainable speed for oil-air lubrication	9300 r/min