

## 95BTR10H TYNDBELP4A NSK

Axial angular contact ball bearing

TYPE: Ball bearings, Axial angular contact ball bearing, Single direction, Contact angle 40°, High speed, duplex, ceramic ball, extra light preload (NSK)

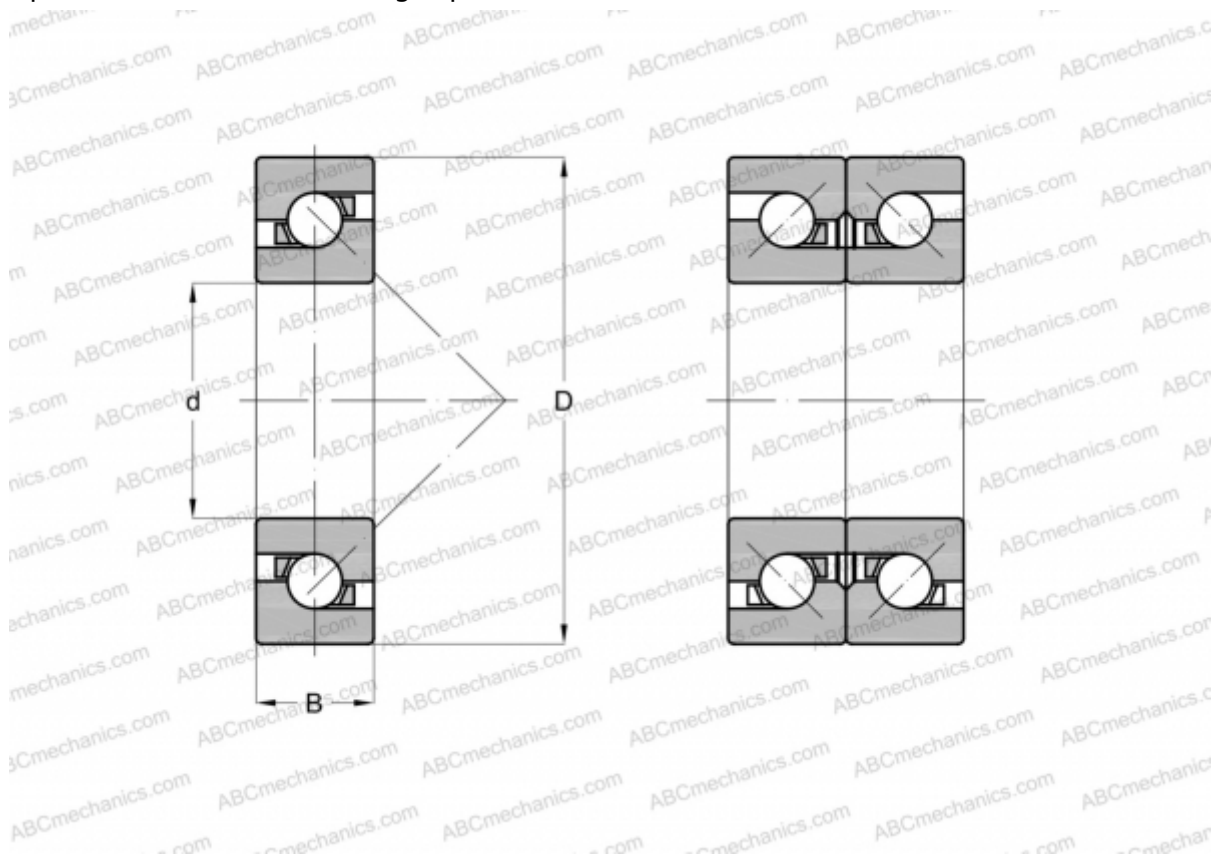

### Technical specification

#### DIMENSIONS, MM

d	95,000
D	145,000
B	22,500

**MANUFACTURER** [NSK](#)

#### CALCULATION DATA

Basic dynamic load rating, C	51,000 kN
Basic static load rating, Co	110,000 kN
Attainable speed for grease lubrication	6300 r/min
Attainable speed for oil-air lubrication	8000 r/min