

25TAC02D NSK

Axial angular contact ball bearing

TYPE: Ball bearings, Axial angular contact ball bearing, Single direction, Contact angle 55°, Series TAC02/TAC03, ball screw support bearings, for high-load drive applications (NSK)

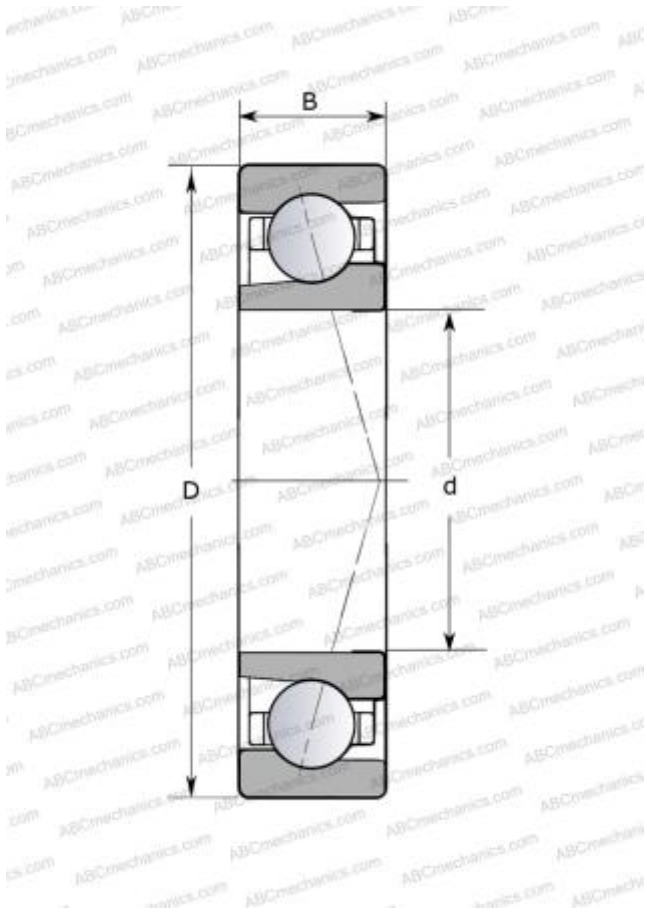

Technical specification

DIMENSIONS, MM

d	25,000
D	52,000
B	15,000

MANUFACTURER

[NSK](#)

CALCULATION DATA

Attainable speed for grease lubrication	7700 r/min
Attainable speed for oil-air lubrication	9700 r/min