

45TAC03D NSK

Axial angular contact ball bearing

TYPE: Ball bearings, Axial angular contact ball bearing, Single direction, Contact angle 55°, Series TAC02/TAC03, ball screw support bearings, for high-load drive applications (NSK)

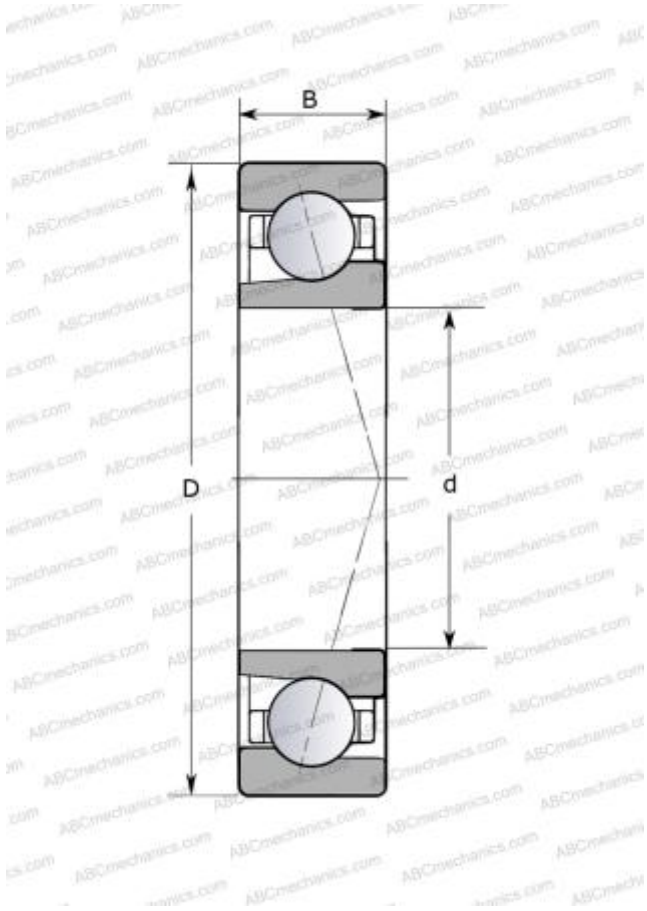

Technical specification

DIMENSIONS, MM

d	45,000
D	100,000
B	25,000

MANUFACTURER

[NSK](#)

CALCULATION DATA

Attainable speed for grease lubrication	4100 r/min
Attainable speed for oil-air lubrication	5200 r/min