

50TAC03D NSK

Axial angular contact ball bearing

TYPE: Ball bearings, Axial angular contact ball bearing, Single direction, Contact angle 55°, Series TAC02/TAC03, ball screw support bearings, for high-load drive applications (NSK)

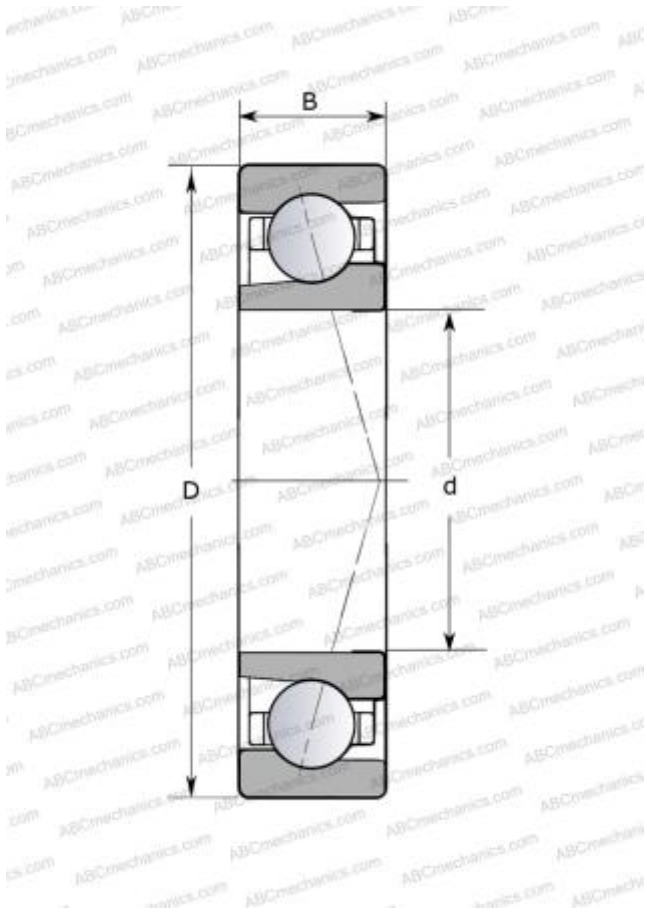

Technical specification

DIMENSIONS, MM

d	50,000
D	110,000
B	27,000

MANUFACTURER

[NSK](#)

CALCULATION DATA

Attainable speed for grease lubrication	3700 r/min
Attainable speed for oil-air lubrication	4700 r/min