

QJ 202 N2MA SKF

Four-point contact bearing

TYPE: Ball bearings, Angular contact ball bearing, Four point contact, Separable, with split inner ring, 2 locating slots in one outer ring

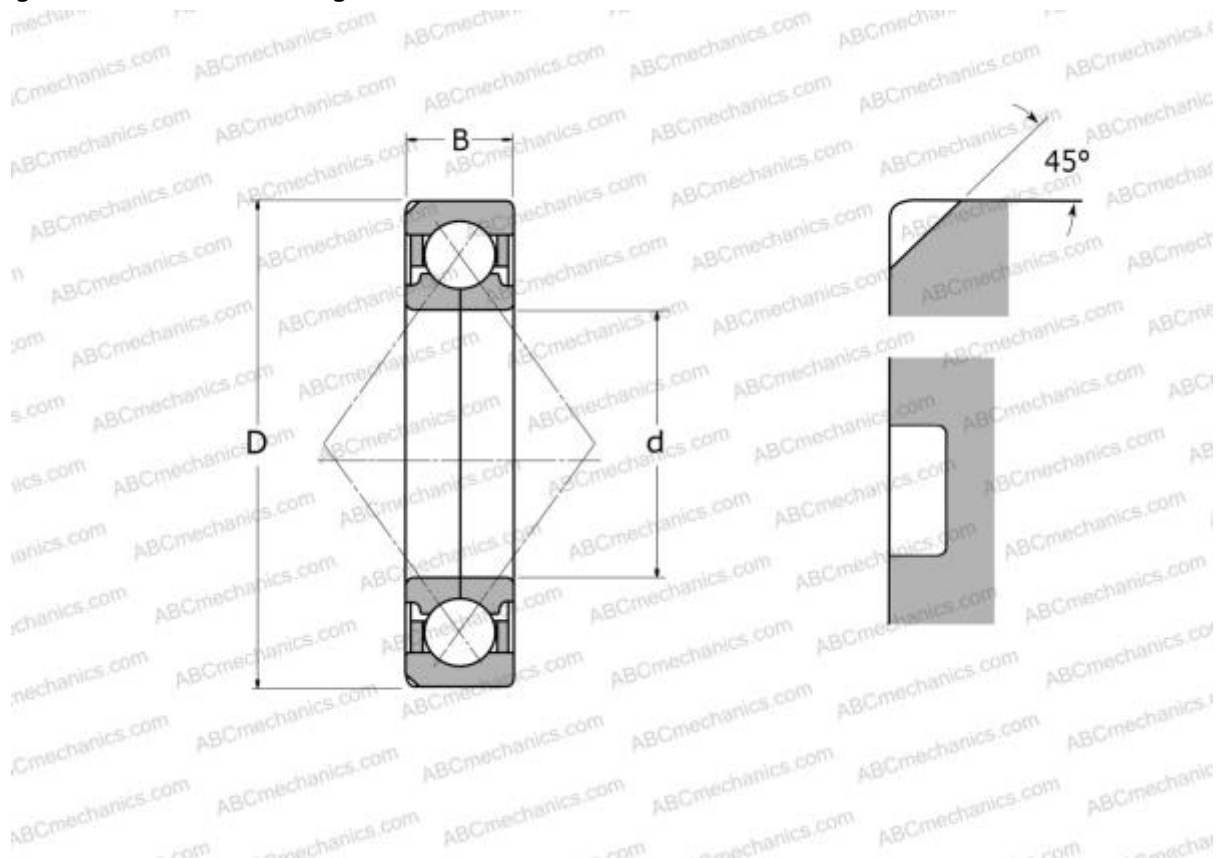

Technical specification

DIMENSIONS, MM

d	15,000
D	35,000
B	11,000

MANUFACTURER [SKF](#)

INTERCHANGE

ABC	QJ 202 N2MA
-----	-----------------------------

CALCULATION DATA

Basic dynamic load rating, C	12,700 kN
Basic static load rating, Co	8,300 kN
Fatigue load limit, Pu	0,360 kN
Reference speed	22000 r/min
Limiting speed	36000 r/min