

## QJ 303 N2MA ABC

Four-point contact bearing

TYPE: Ball bearings, Angular contact ball bearing, Four point contact, Separable, with split inner ring, 2 locating slots in one outer ring

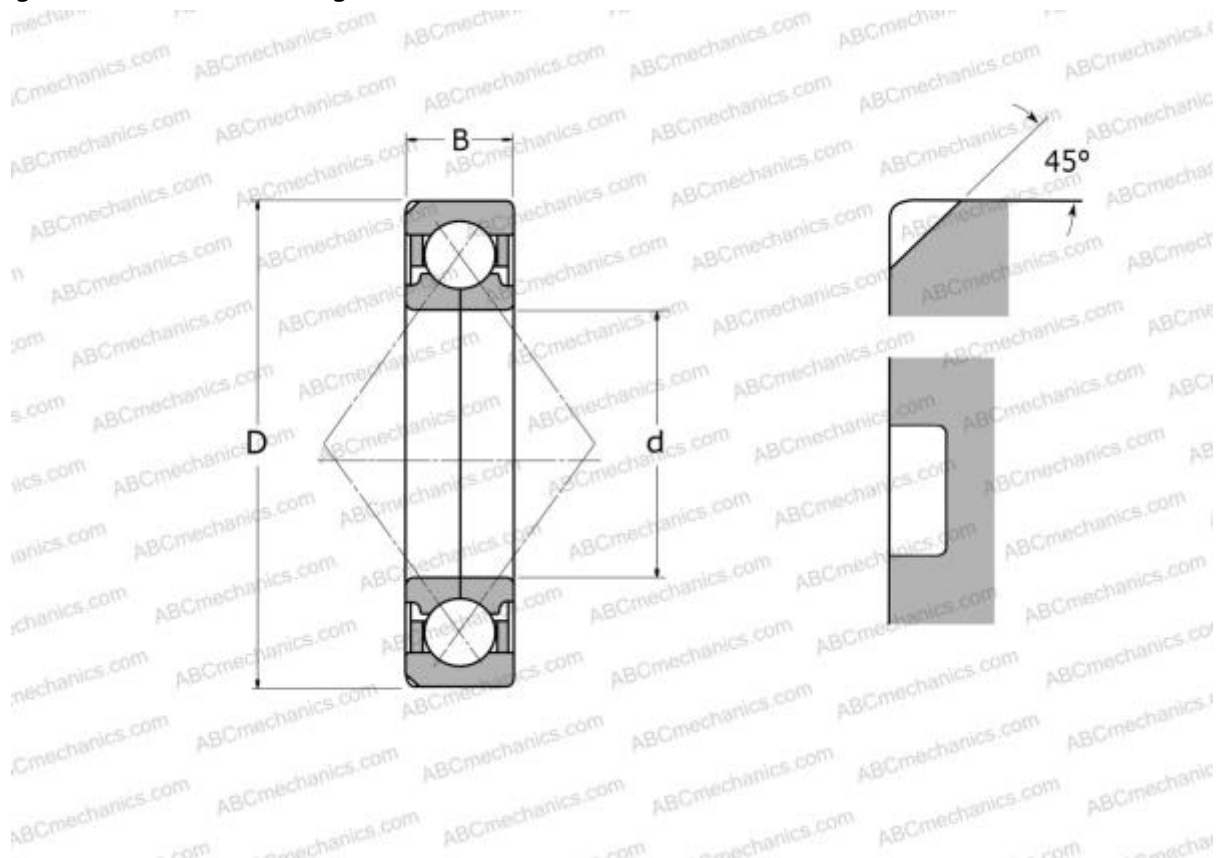

### Technical specification

#### DIMENSIONS, MM

d	17,000
D	47,000
B	14,000

**MANUFACTURER** [ABC](#)

#### INTERCHANGE

SKF [QJ 303 N2MA](#)