

QJ 303 N2MA SKF

Four-point contact bearing

TYPE: Ball bearings, Angular contact ball bearing, Four point contact, Separable, with split inner ring, 2 locating slots in one outer ring

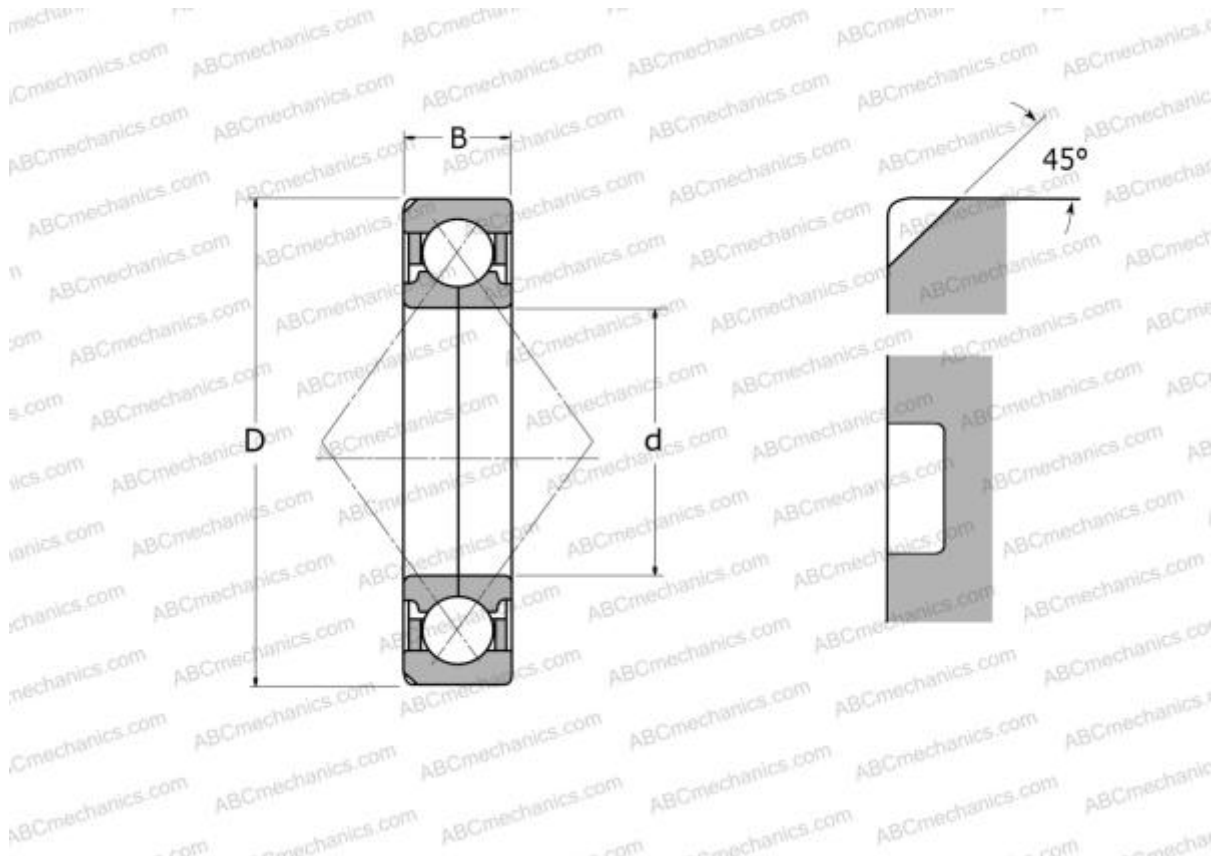

Technical specification

DIMENSIONS, MM

d	17,000
D	47,000
B	14,000

MANUFACTURER [SKF](#)

INTERCHANGE

ABC [QJ 303 N2MA](#)

CALCULATION DATA

Basic dynamic load rating, C	23,400 kN
Basic static load rating, Co	15,000 kN
Fatigue load limit, Pu	0,640 kN
Reference speed	17000 r/min
Limiting speed	28000 r/min