

2206 E-2RS1KTN9 SKF

Self-aligning ball bearings

TYPE: Ball bearings, Radial ball bearings, Double row, spherical, With tapered bore, With adapter sleeve, seals 2RS

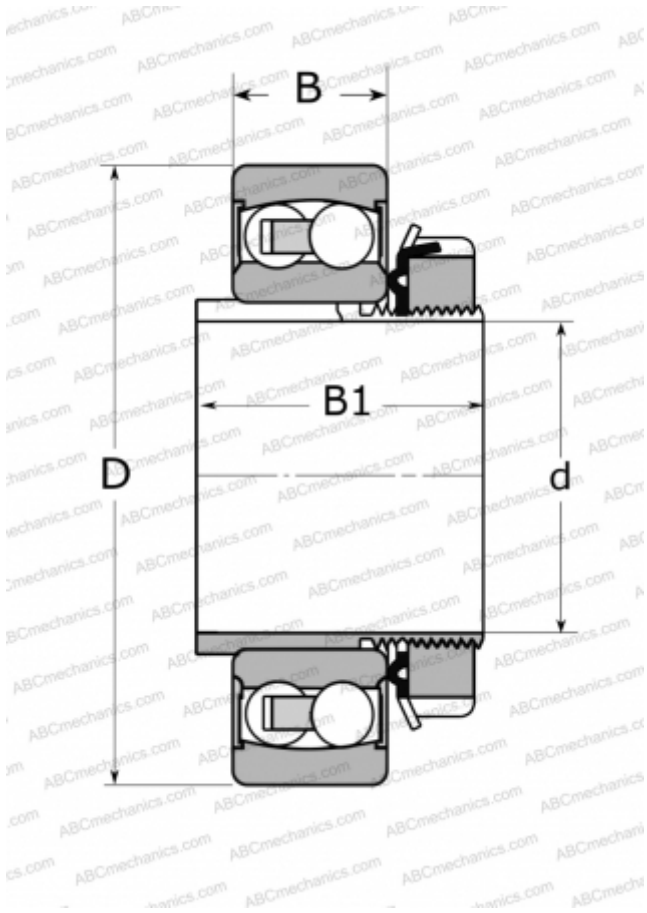

Technical specification

DIMENSIONS, MM

d	30,000
D	62,000
B	20,000
B1	31,000

MANUFACTURER

[SKF](#)

INTERCHANGE

ABC	2206 K 2RS
FAG	2206-K-2RS-TVH-C3

CALCULATION DATA

Basic dynamic load rating, C	15,600 kN
Basic static load rating, Co	4,650 kN
Fatigue load limit, Pu	0,240 kN
Limiting speed	7500 r/min

ASSOCIATED PRODUCTS

H 306 C