

2207-K-2RS-TVH-C3 FAG

Self-aligning ball bearings

TYPE: Ball bearings, Radial ball bearings, Double row, spherical, With tapered bore, With adapter sleeve, seals 2RS

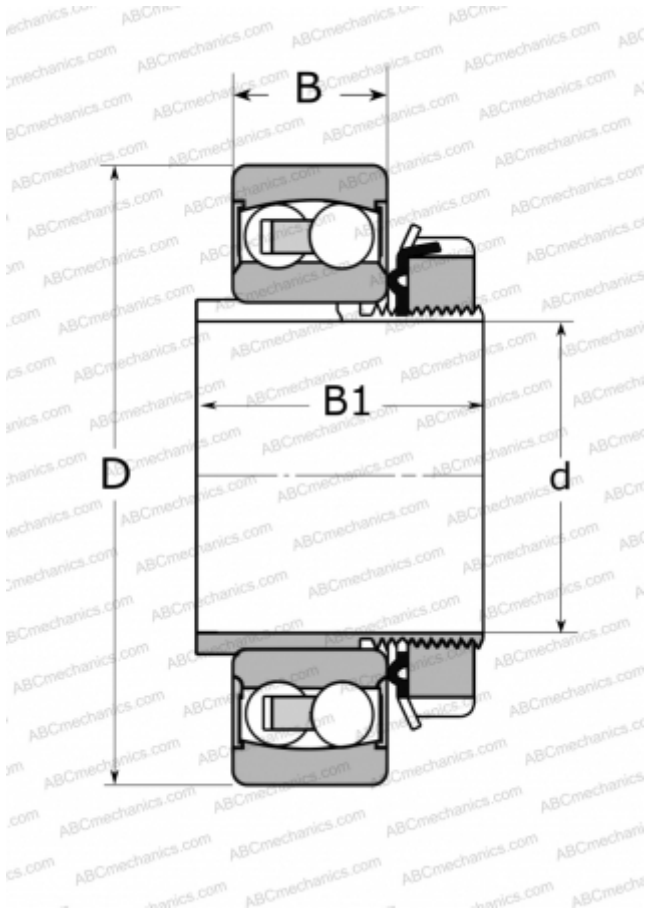

Technical specification

DIMENSIONS, MM

d	35,000
D	72,000
B	23,000
B1	35,000

MANUFACTURER

[FAG](#)

INTERCHANGE

ABC	2207 K 2RS
SKF	2207 E-2RS1KTN9

CALCULATION DATA

Basic dynamic load rating, C	16,000 kN
Basic static load rating, Co	5,100 kN
Fatigue load limit, Pu	0,315 kN
Limiting speed	7000 r/min

ASSOCIATED PRODUCTS

H307