

BA 3 ABC

Thrust ball bearings

TYPE: Ball bearings, Thrust ball bearing, Single direction, Separable

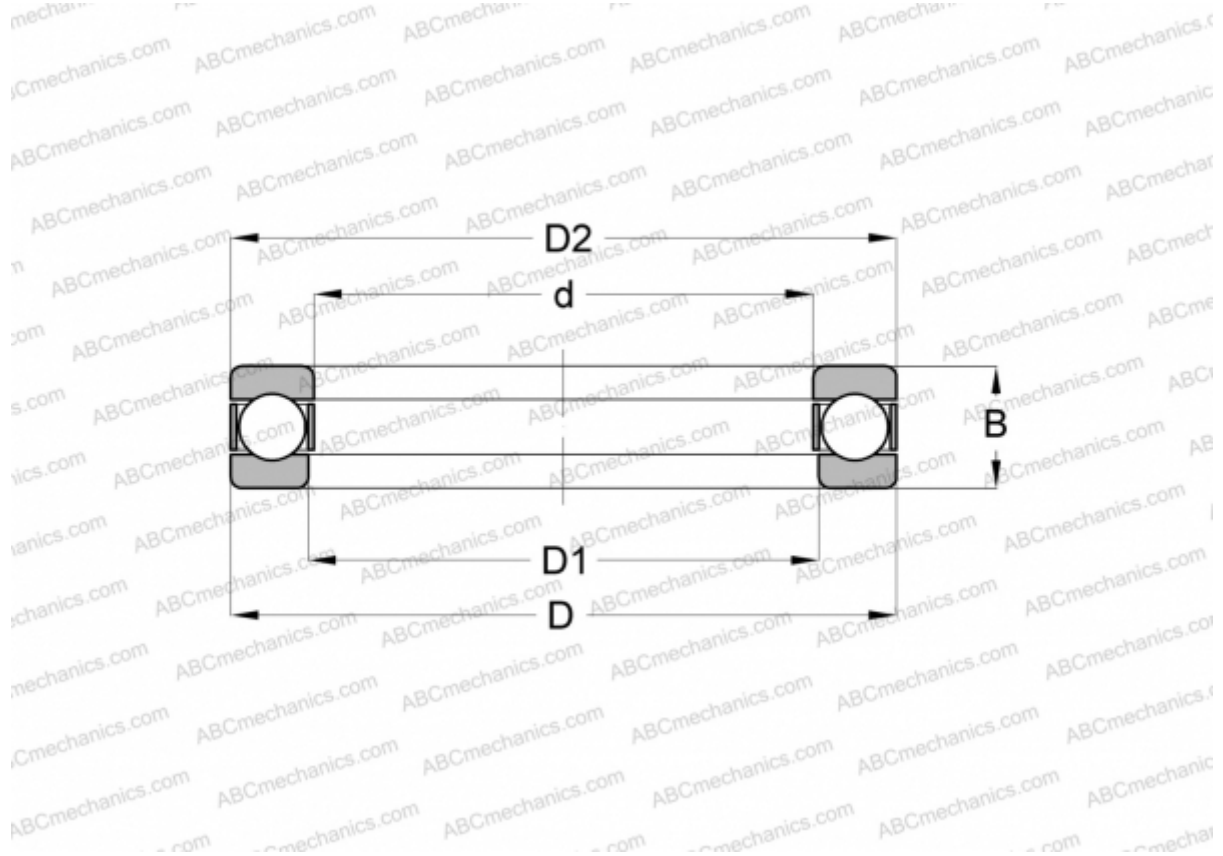

Technical specification

DIMENSIONS, MM

d	3,000
D	8,000
D1	3,200
D2	7,800
B	3,500

MANUFACTURER [ABC](#)

INTERCHANGE

SKF [BA 3](#)