

BA 3 SKF

Thrust ball bearings

TYPE: Ball bearings, Thrust ball bearing, Single direction, Separable

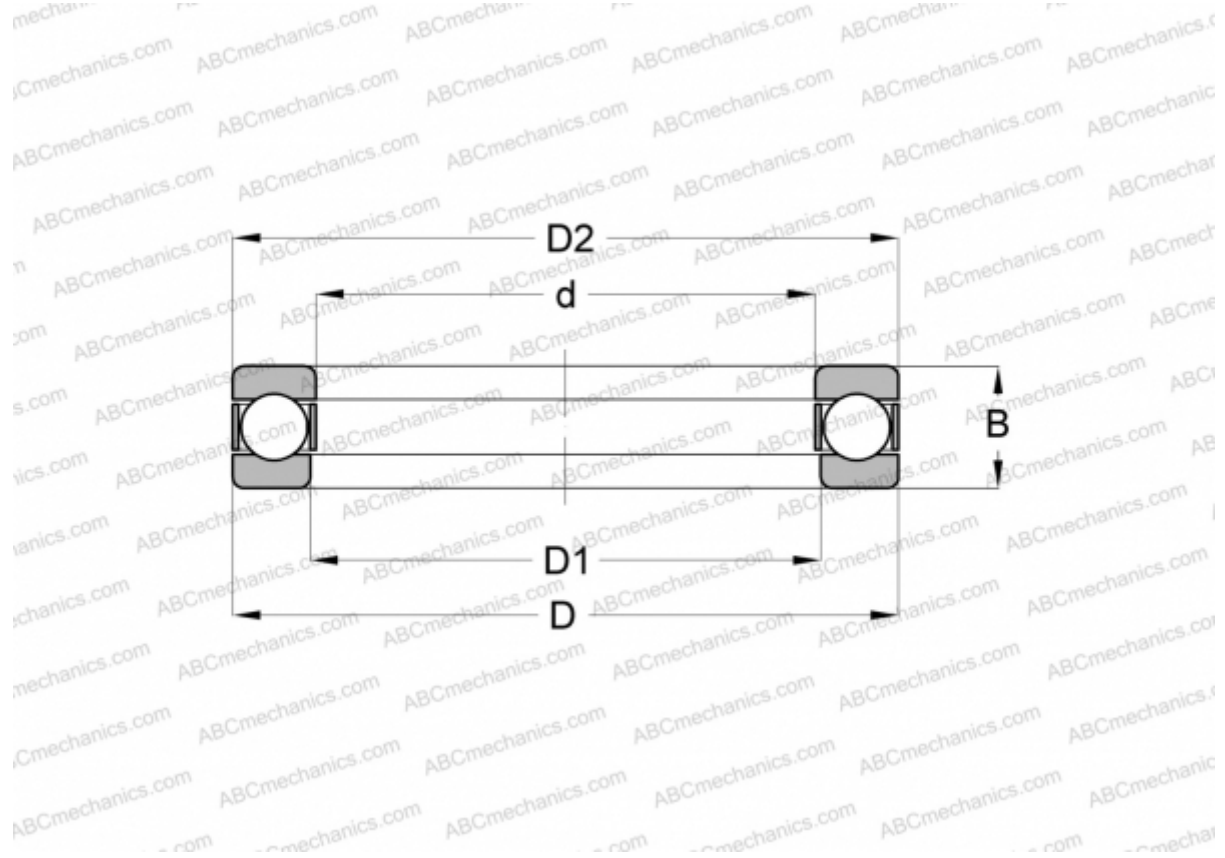

Technical specification

DIMENSIONS, MM

d	3,000
D	8,000
D1	3,200
D2	7,800
B	3,500

MANUFACTURER [SKF](#)

INTERCHANGE

ABC [BA 3](#)

CALCULATION DATA

Basic dynamic load rating, C	0,806 kN
Basic static load rating, Co	0,720 kN
Fatigue load limit, Pu	0,027 kN
Reference speed	8000 r/min
Limiting speed	11000 r/min