

BA 6 SKF

Thrust ball bearings

TYPE: Ball bearings, Thrust ball bearing, Single direction, Separable

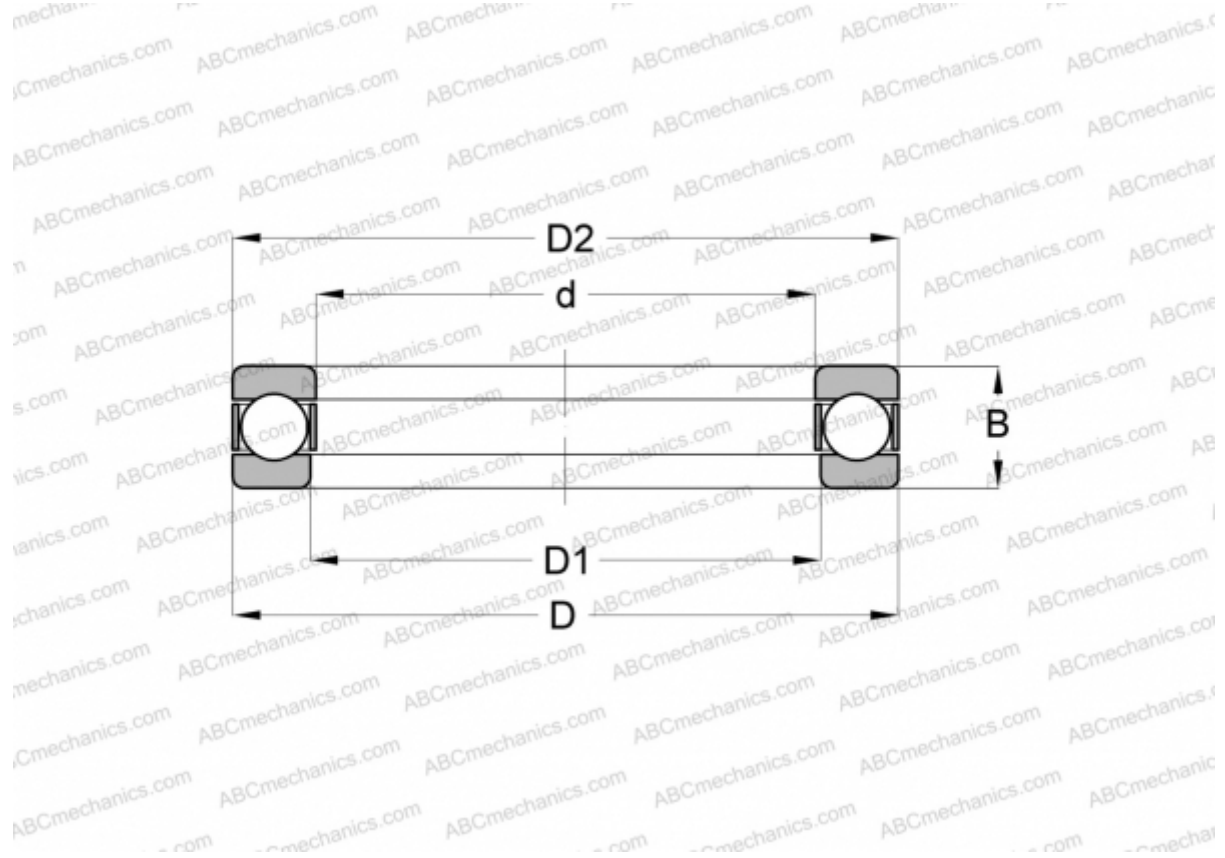

Technical specification

DIMENSIONS, MM

d	6,000
D	14,000
D1	6,200
D2	13,800
B	5,000

MANUFACTURER [SKF](#)

INTERCHANGE

ABC [BA 6](#)

CALCULATION DATA

Basic dynamic load rating, C	1,780 kN
Basic static load rating, Co	1,920 kN
Fatigue load limit, Pu	0,071 kN
Reference speed	6000 r/min
Limiting speed	8000 r/min