

29412-E1 FAG

Spherical roller thrust bearings

TYPE: Roller bearings, Thrust roller bearing, Axial spherical

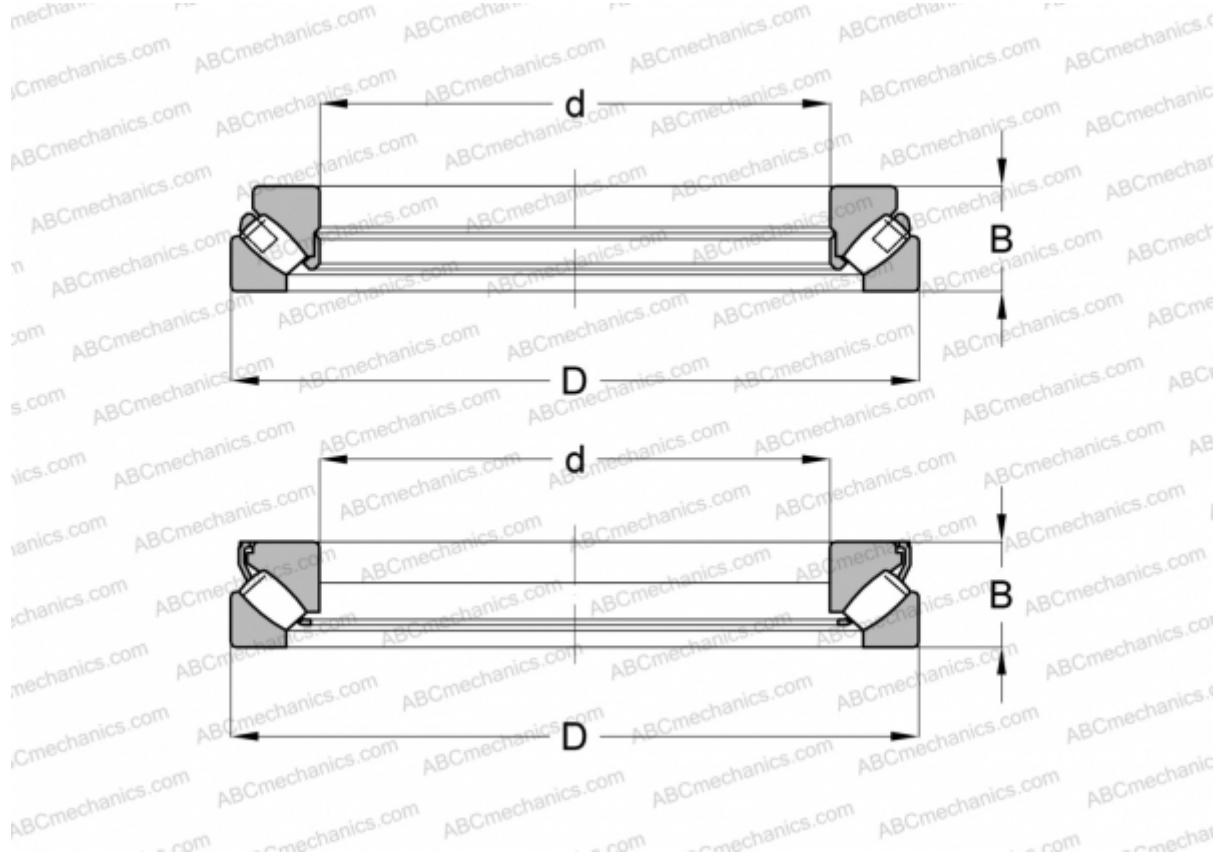

Technical specification

DIMENSIONS, MM

d	60,000
D	130,000
B	42,000

MANUFACTURER [FAG](#)

INTERCHANGE

ABC	29412E
SKF	29412 E

CALCULATION DATA

Basic dynamic load rating, C	420,000 kN
Basic static load rating, Co	970,000 kN
Fatigue load limit, Pu	116,000 kN
Reference speed	2750 r/min
Limiting speed	6000 r/min