

29414-E1 FAG

Spherical roller thrust bearings

TYPE: Roller bearings, Thrust roller bearing, Axial spherical

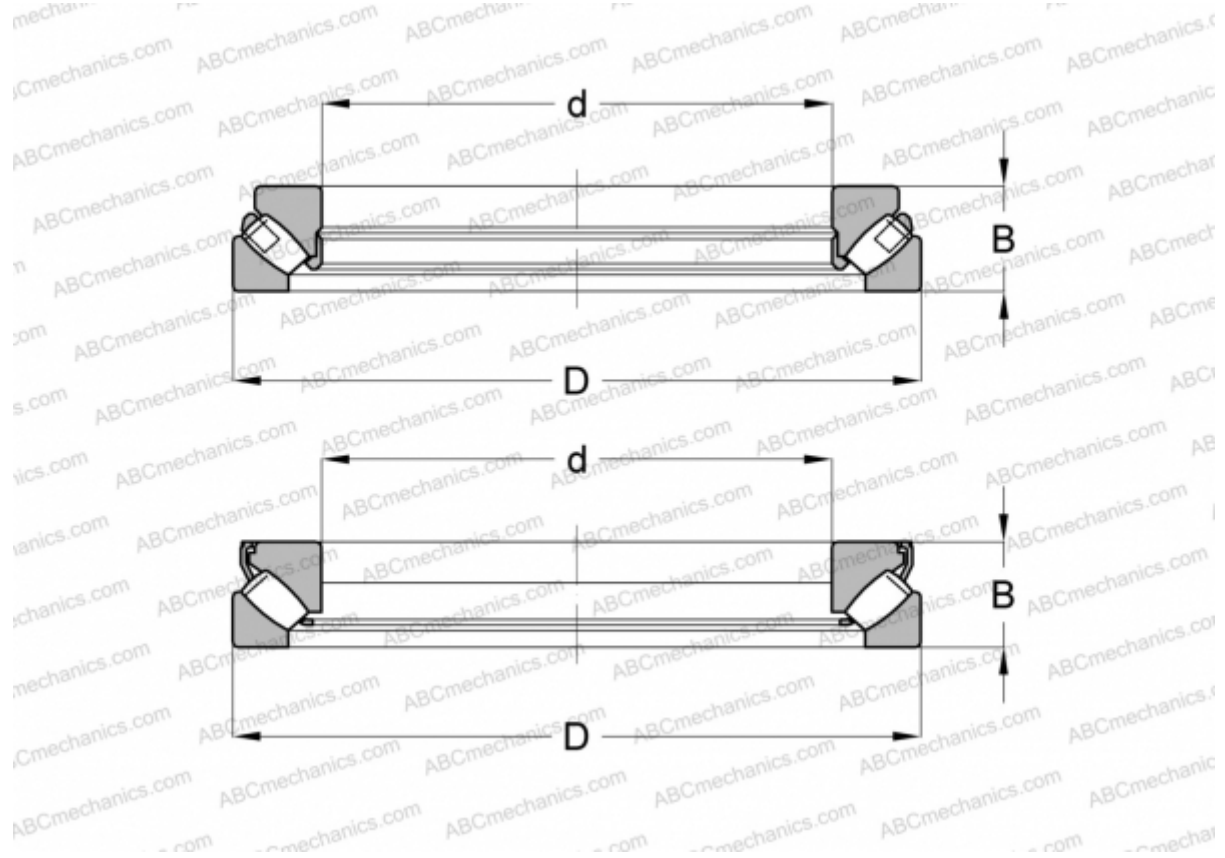

Technical specification

DIMENSIONS, MM

d	70,000
D	150,000
B	48,000

MANUFACTURER [FAG](#)

INTERCHANGE

ABC	29414E
SKF	29414 E

CALCULATION DATA

Basic dynamic load rating, C	550,000 kN
Basic static load rating, Co	1290,000 kN
Fatigue load limit, Pu	151,000 kN
Reference speed	2420 r/min
Limiting speed	5000 r/min