

NATR6-X-PP INA

Yoke type track roller

TYPE: Roller bearings, Yoke type track rollers, With axial guidance, Sealing rings on both sides, cylindrical outer ring

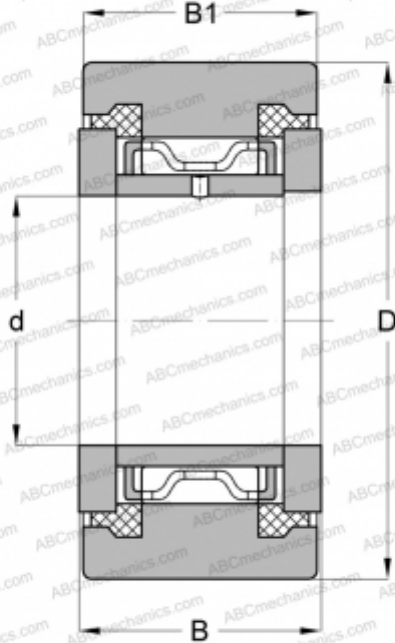

Technical specification

DIMENSIONS, MM

d	6,000
D	19,000
B	12,000
B1	11,000

MANUFACTURER

[INA](#)

INTERCHANGE

ABC	NATR 6 PPX
McGill	MCYRR 6 SX
SKF	NATR 6 PPX

CALCULATION DATA

Basic dynamic load rating, C	3,500 kN
Basic static load rating, Co	4,000 kN
Fatigue load limit, Pu	0,540 kN
Limiting speed	11000 r/min