

KR 19 SKF

Cam followers

TYPE: Roller bearings, Stud type track rollers, With axial guidance, gap seals on both side

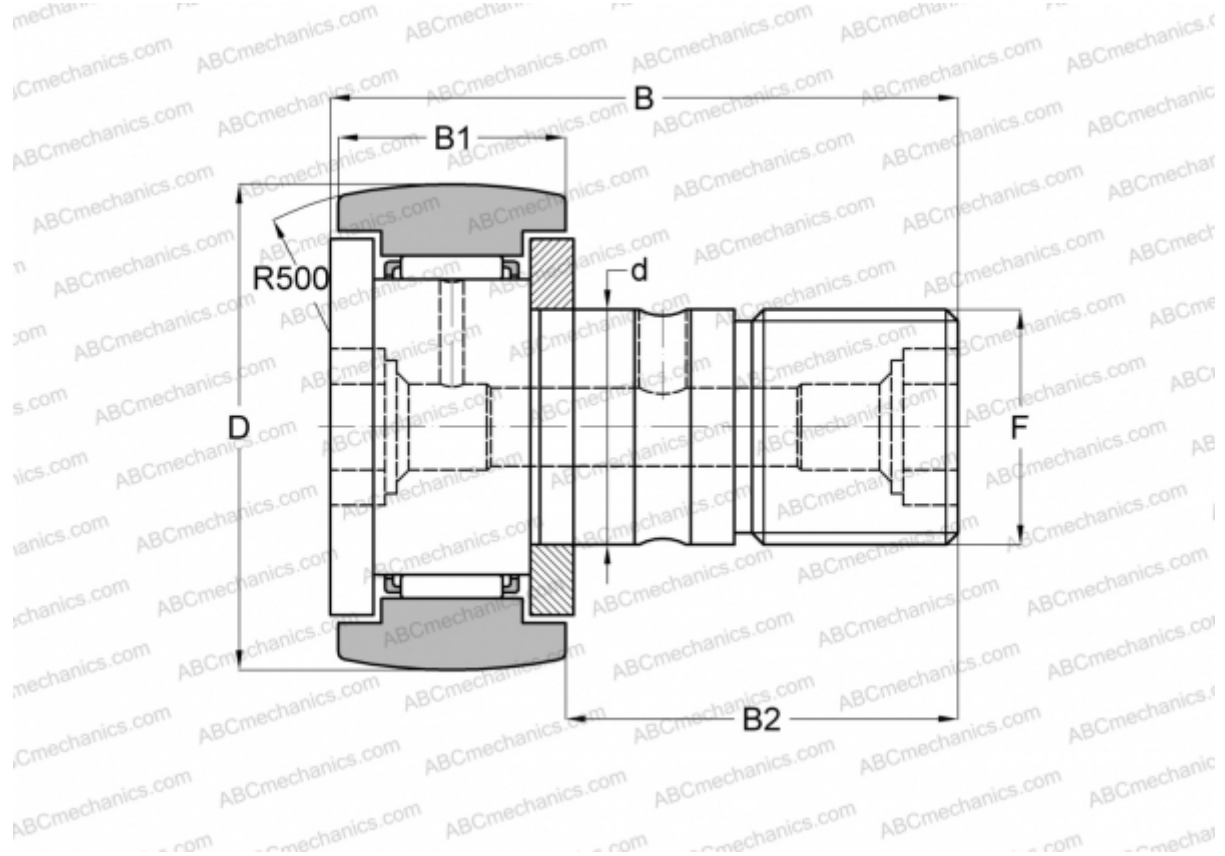

Technical specification

DIMENSIONS, MM

d	8,000
D	19,000
B	32,000
B1	11,000
B2	20,000
F	M8

CALCULATION DATA

Basic dynamic load rating, C	3,470 kN
Basic static load rating, Co	3,800 kN
Fatigue load limit, Pu	0,415 kN
Limiting speed	5600 r/min

MANUFACTURER

[SKF](#)

INTERCHANGE

ABC	KR 19
IKO	CF 8 R
McGill	MCFR-19
FAG	KR 19
INA	KR19