

NUKRE52 INA

Cam followers

TYPE: Roller bearings, Stud type track rollers, With axial guidance, full complement cylindrical roller set, with eccentric collar, labyrinth seals on both sides

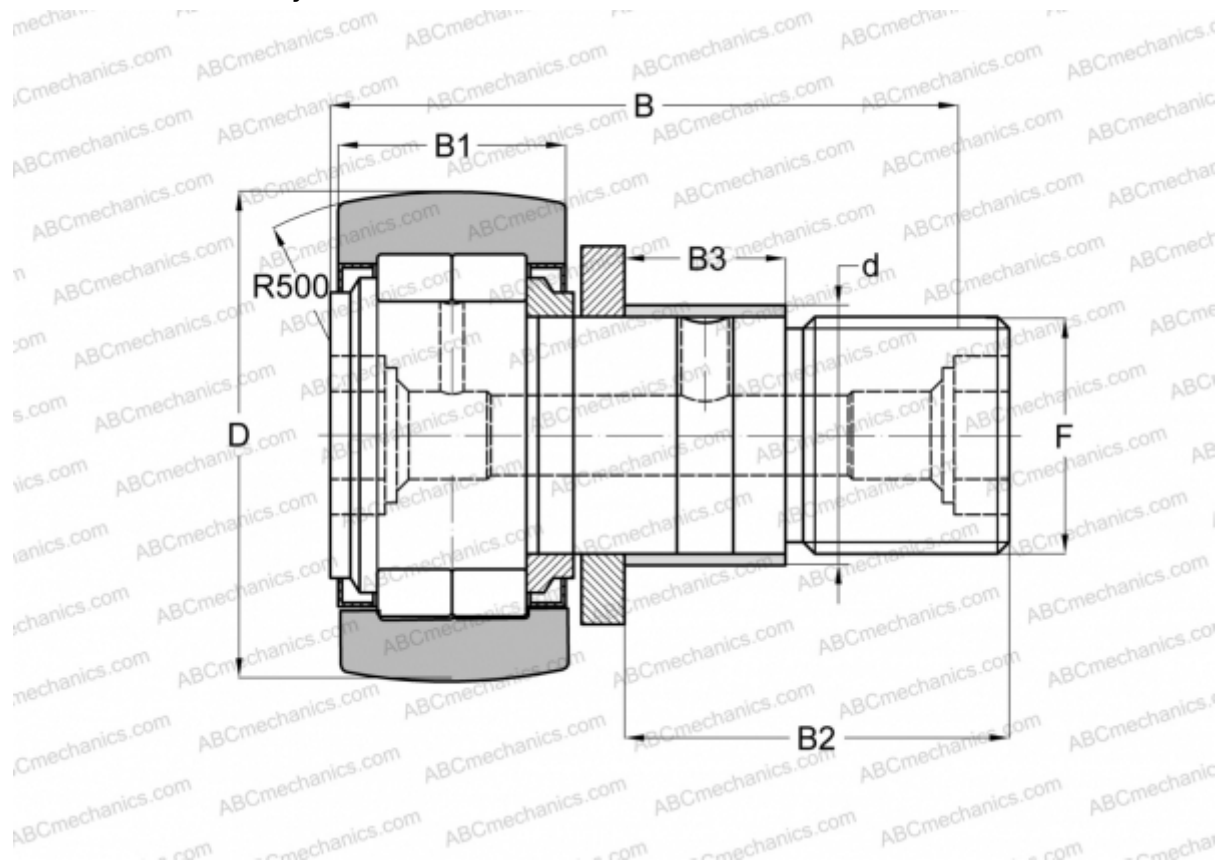

Technical specification

DIMENSIONS, MM

d	20,000
D	52,000
B	66,000
B1	25,000
B2	40,000
F	M20X1,5

CALCULATION DATA

Fatigue load limit, Pu	5,300 kN
Limiting speed	4200 r/min

MANUFACTURER

[INA](#)

INTERCHANGE

ABC	NUKRE 52
FAG	NUKRE 52 C
SKF	NUKRE 52 A

CALCULATION DATA

Basic dynamic load rating, C	29,000 kN
Basic static load rating, Co	40,500 kN