

NUKRE47-X INA

Cam followers

TYPE: Roller bearings, Stud type track rollers, With axial guidance, full complement cylindrical roller set, with eccentric collar, labyrinth seals on both sides, cylindrical outer ring

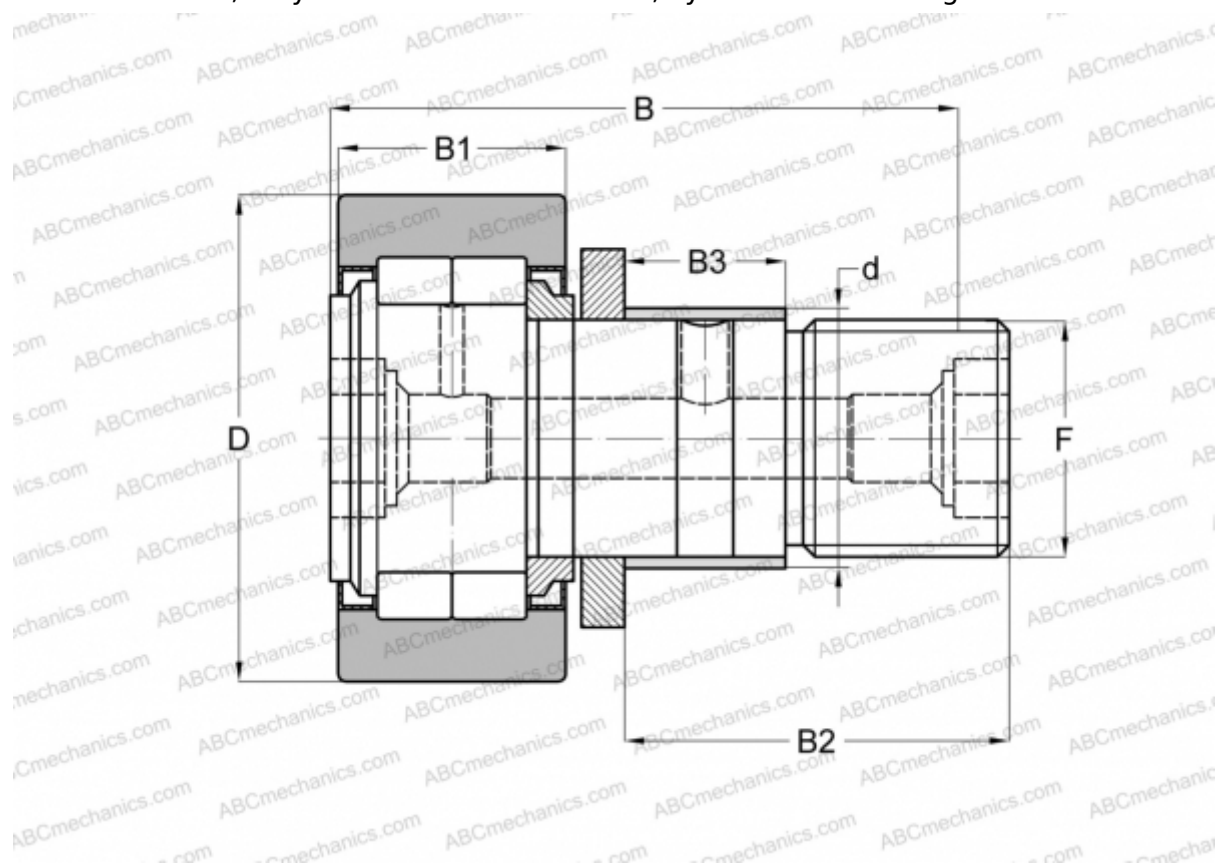

Technical specification

DIMENSIONS, MM

d	20,000
D	47,000
B	66,000
B1	25,000
B2	40,000
F	M20X1,5

CALCULATION DATA

Fatigue load limit, Pu	4,850 kN
Limiting speed	4200 r/min

MANUFACTURER

[INA](#)

INTERCHANGE

ABC	NUKRE 47 X
FAG	NUKRE 47 C DZ
SKF	NUKRE 47 X

CALCULATION DATA

Basic dynamic load rating, C	28,500 kN
Basic static load rating, Co	37,500 kN