

LR50/6-X-2RSR INA

Track rollers

TYPE: Ball bearings, Track rollers, Double row, Without profile, Sealed on both sides, cylindrical outer ring

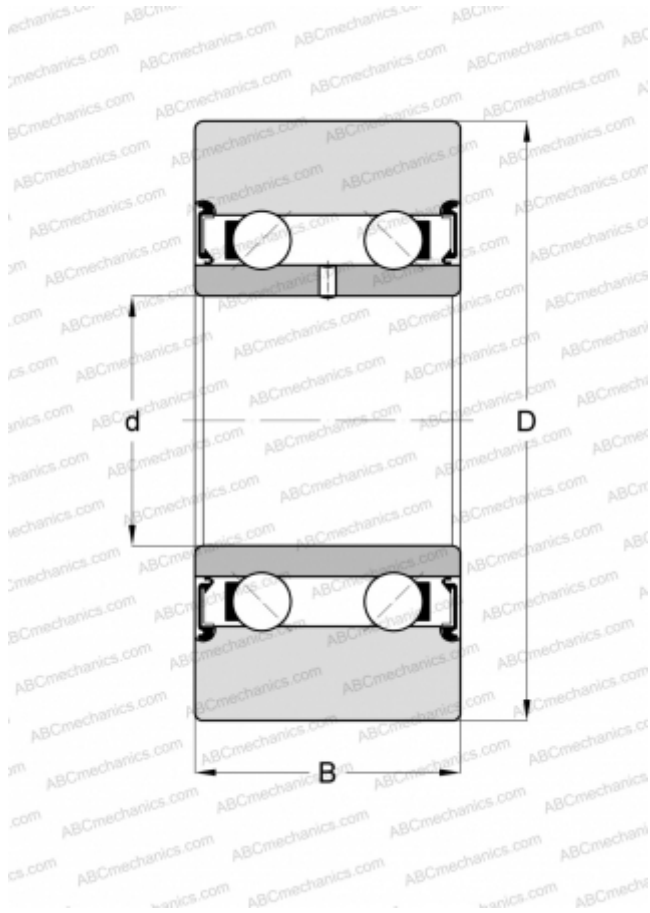

Technical specification

DIMENSIONS, MM

d	6,000
D	19,000
B	9,000

MANUFACTURER

[INA](#)

INTERCHANGE

ABC	LR50/6-X-2RS
-----	------------------------------

CALCULATION DATA

Basic dynamic load rating, C	2,700 kN
Basic static load rating, Co	1,370 kN
Fatigue load limit, Pu	0,066 kN
Limiting speed	11000 r/min