

ZKLFA0630-2Z INA

Axial angular contact ball bearing

TYPE: Ball bearings, Axial angular contact ball bearing, Unit, Series ZKLFA, double direction, with flange, gap seals on both side

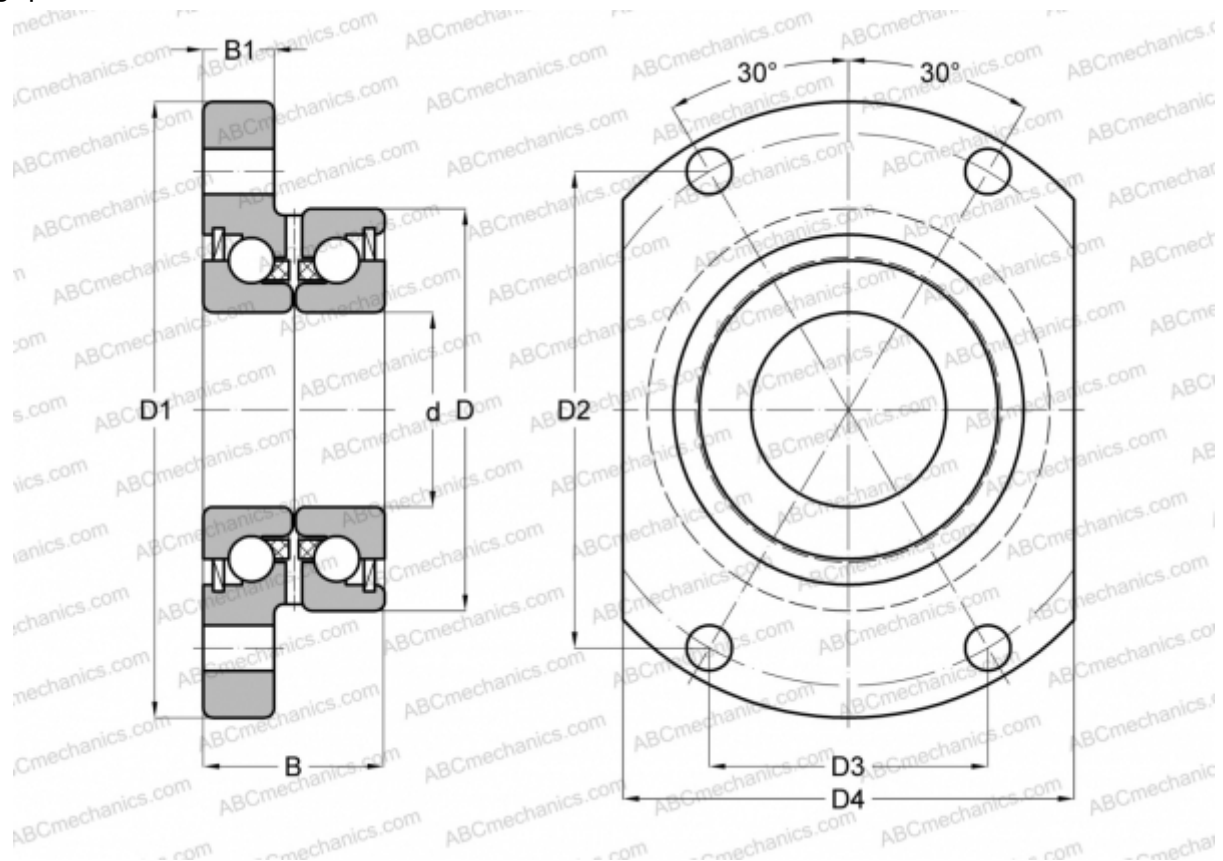

Technical specification

DIMENSIONS, MM

d	6,000
D	19,000
D1	30,000
D2	21,000
D3	12,000
D4	22,000
B	12,000
B1	5,000

MANUFACTURER

[INA](#)

CALCULATION DATA

Basic dynamic load rating, C	4,900 kN
Basic static load rating, Co	6,100 kN
Limiting speed	14000 r/min

ASSOCIATED PRODUCTS

ZM06