

ZKLFA0640-2RS INA

Axial angular contact ball bearing

TYPE: Ball bearings, Axial angular contact ball bearing, Unit, Series ZKLFA, double direction, with flange, lip seals on both side

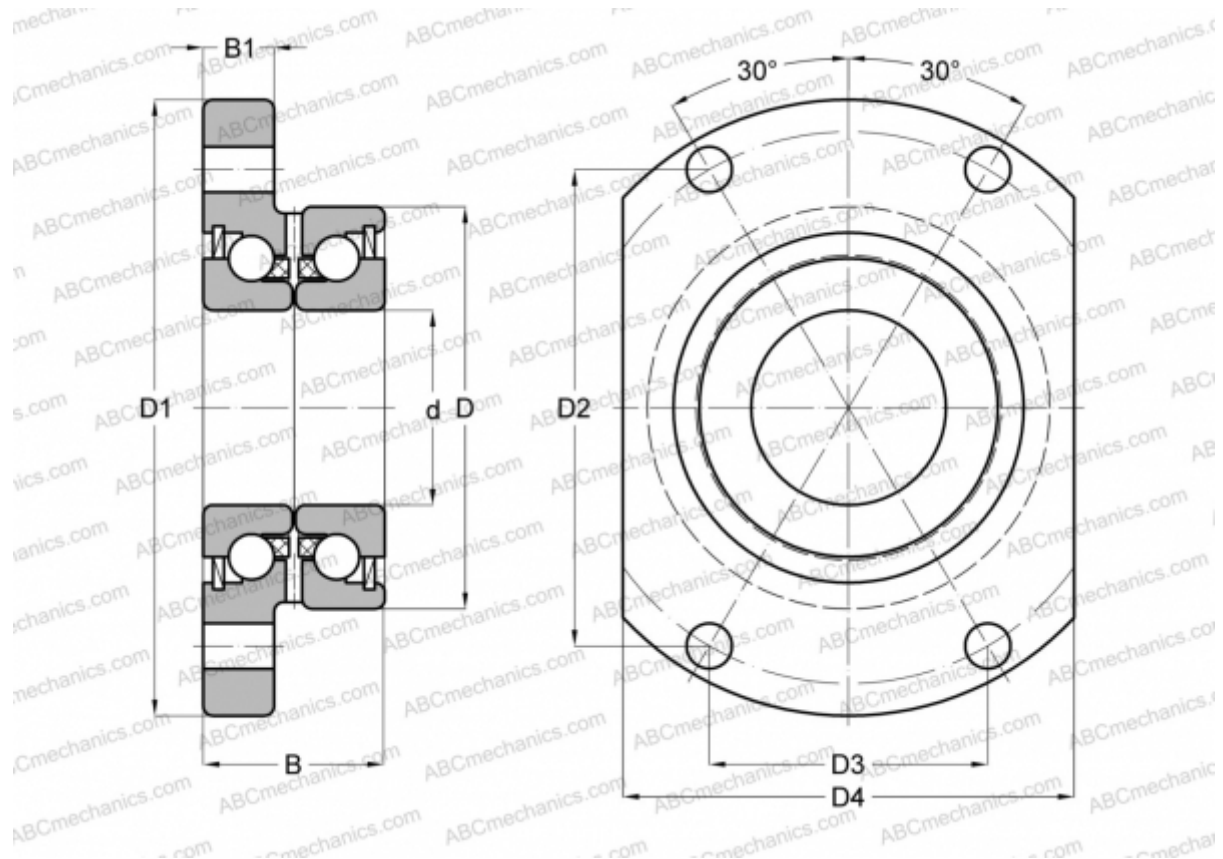

Technical specification

DIMENSIONS, MM

d	6,000
D	24,000
D1	40,000
D2	27,500
D3	16,000
D4	27,000
B	15,000
B1	6,000

MANUFACTURER

[INA](#)

CALCULATION DATA

Basic dynamic load rating, C	6,900 kN
Basic static load rating, Co	8,500 kN
Limiting speed	6800 r/min

ASSOCIATED PRODUCTS

ZM06