

ZKLFA0850-2RS INA

Axial angular contact ball bearing

TYPE: Ball bearings, Axial angular contact ball bearing, Unit, Series ZKLFA, double direction, with flange, lip seals on both side

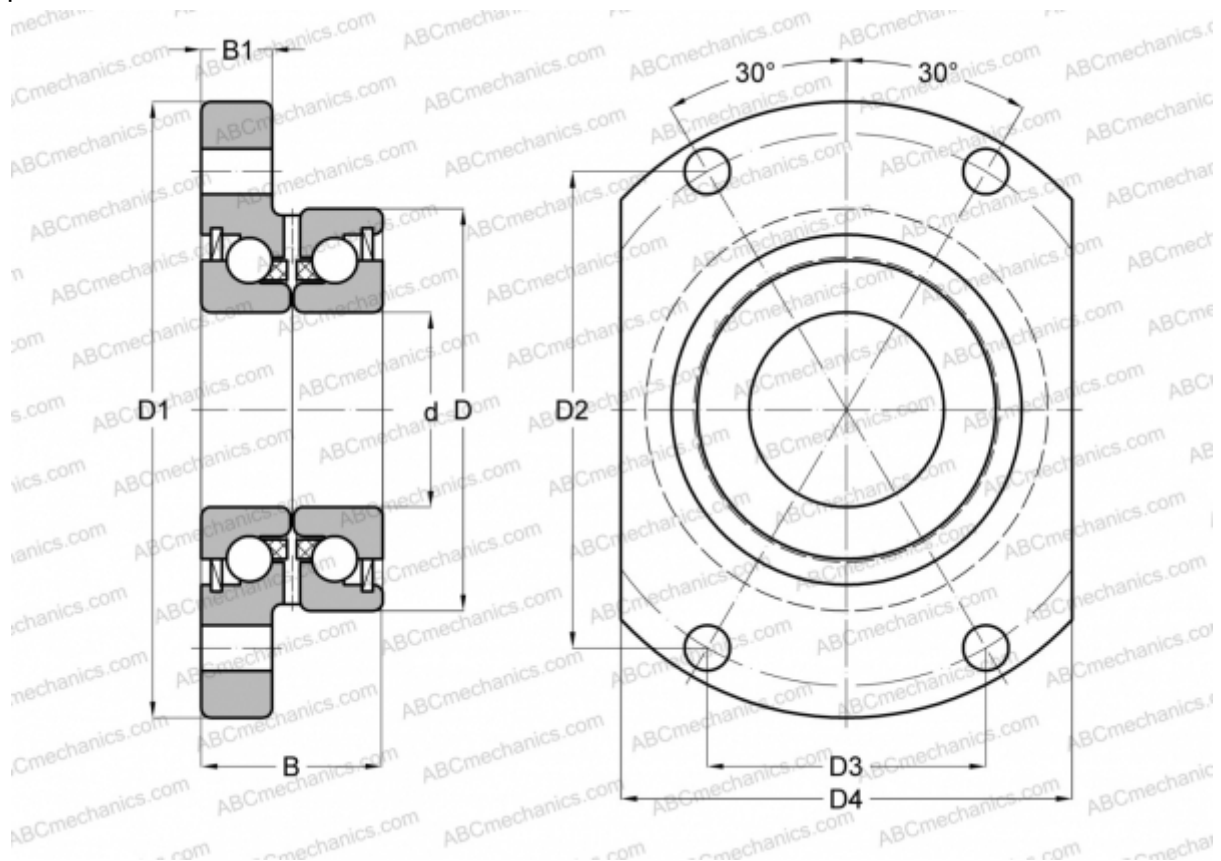

Technical specification

DIMENSIONS, MM

d	8,000
D	32,000
D1	50,000
D2	34,500
D3	20,000
D4	35,000
B	20,000
B1	8,000

MANUFACTURER

[INA](#)

CALCULATION DATA

Basic dynamic load rating, C	12,500 kN
Basic static load rating, Co	16,300 kN
Limiting speed	5100 r/min

ASSOCIATED PRODUCTS

ZM08