

RAE12-NPP-B INA

Insert bearings

TYPE: Ball bearings, Radial insert bearings, With eccentric locking collar, Spherical outer ring, Seals on both side, P seal, without re-relubrication

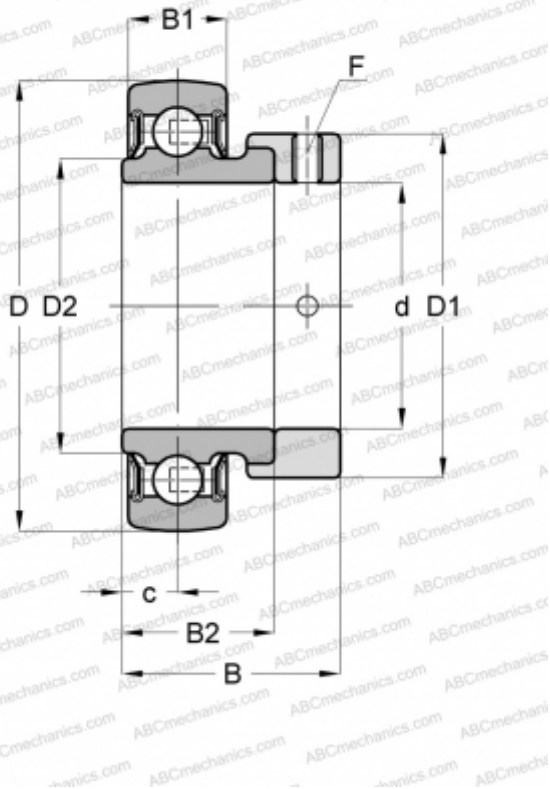

Technical specification

DIMENSIONS, MM

d	12,000
D	40,000
D1	28,000
D2	23,000
B	28,600
B1	12,000
B2	19,000
c	6,500
F	3

MANUFACTURER

[INA](#)

CALCULATION DATA

Basic dynamic load rating, C	9,800 kN
Basic static load rating, Co	4,750 kN
Operating temperature min	-20 °C
Operating temperature max	120 °C

REPLACES

RAE12-XL-NPP-B