

UGW 202+ER ABC

Insert bearings

TYPE: Ball bearings, Radial insert bearings, With eccentric locking collar, Spherical outer ring, Seals on both side, R seal, relubrication

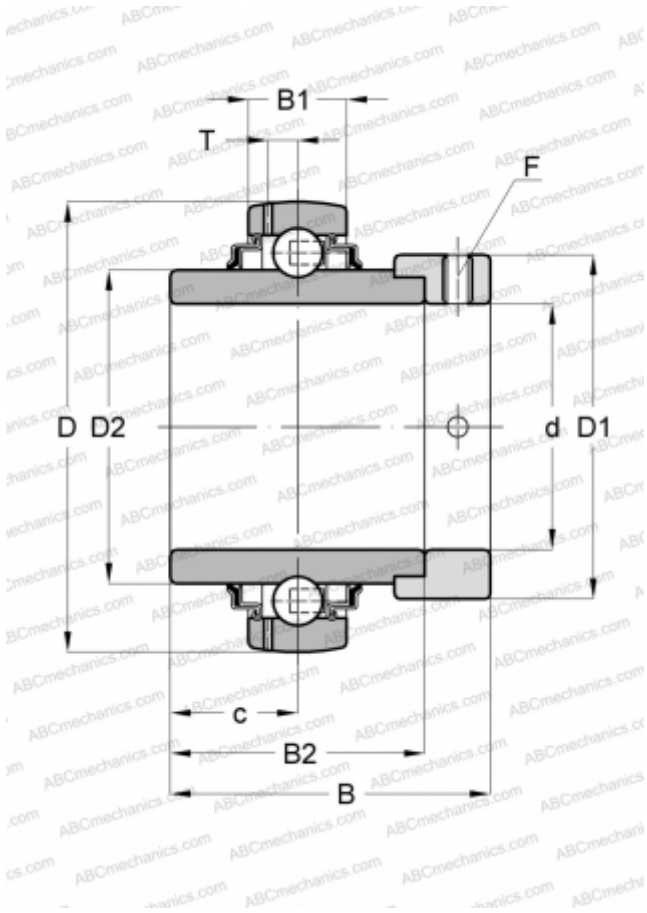

Technical specification

DIMENSIONS, MM

d	15,000
D	40,000
B	37,300
B1	15,000
B2	27,800

MANUFACTURER

[ABC](#)

INTERCHANGE

ASAHI	UGW 202+ER
SLB	UEL202
FYH	NA202