

UGW 202+ER ASAHI

Insert bearings

TYPE: Ball bearings, Radial insert bearings, With eccentric locking collar, Spherical outer ring, Seals on both side, R seal, relubrication

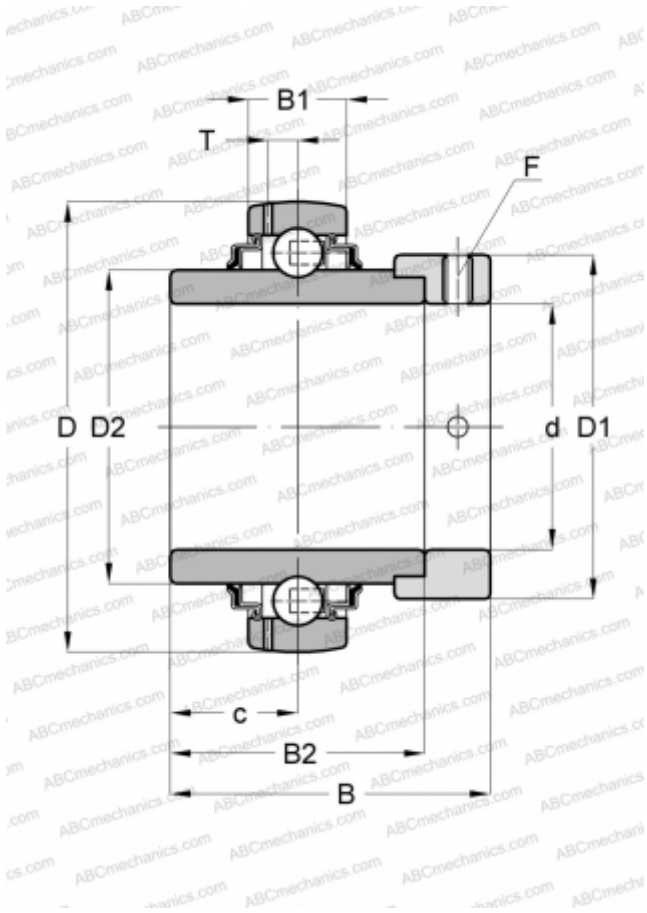

Technical specification

DIMENSIONS, MM

d	15,000
D	40,000
D1	28,600
B	37,300
B1	15,000
B2	27,800
c	13,900
T	4,000
F	M6 x 0.75

MANUFACTURER

[ASAHI](#)

INTERCHANGE

ABC	UGW 202+ER
SLB	UEL202
FYH	NA202