

## GE40-KRR-B ABC

Insert bearings

TYPE: Ball bearings, Radial insert bearings, With eccentric locking collar, Spherical outer ring, Seals on both side, R seal, relubrication

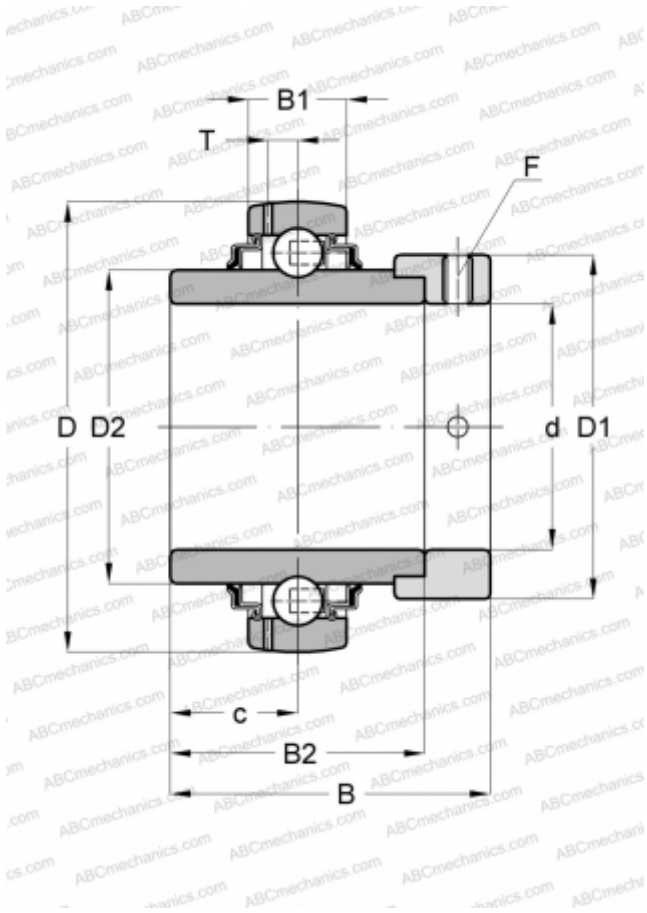

### Technical specification

#### DIMENSIONS, MM

d	40,000
D	80,000
B	56,500
B1	21,000
B2	42,900

#### MANUFACTURER

[ABC](#)

#### INTERCHANGE

ASAHI	<a href="#">UG 208+ER</a>
SKF	<a href="#">YEL 208-2F</a>
INA	<a href="#">GE40-KRR-B</a>
SNR	<a href="#">EX208G2</a>
SLB	<a href="#">UEL208</a>
FYH	<a href="#">NA208</a>
NTN	<a href="#">UEL 208 D1 W3</a>