

## UG 212+ER ASAHI

Insert bearings

TYPE: Ball bearings, Radial insert bearings, With eccentric locking collar, Spherical outer ring, Seals on both side, R seal, relubrication

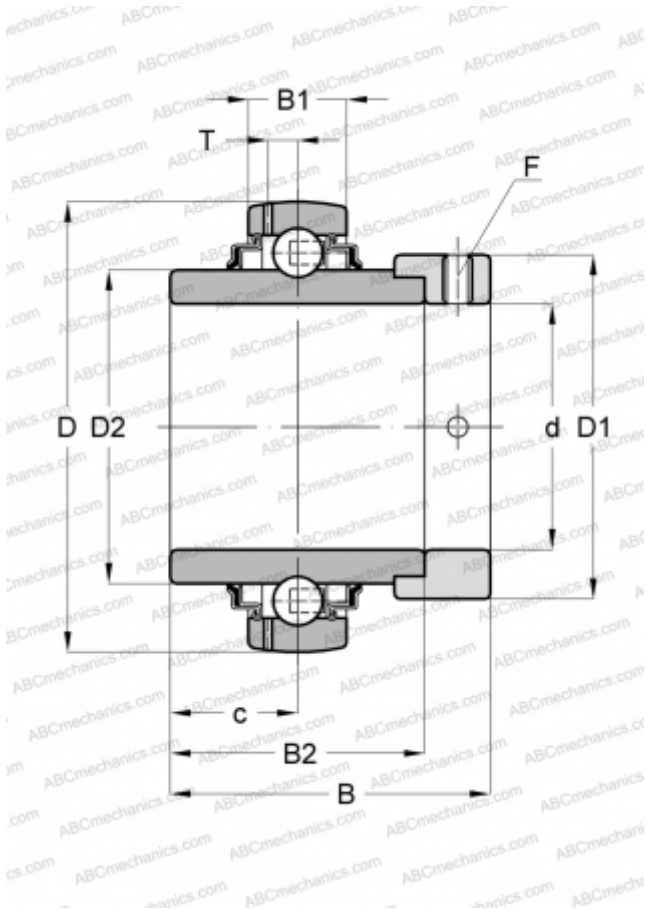

### Technical specification

#### DIMENSIONS, MM

d	60,000
D	110,000
D1	84,200
B	77,800
B1	26,000
B2	61,900
c	31,000
T	7,700
F	M12 x 1.5

#### MANUFACTURER

[ASAHI](#)

#### INTERCHANGE

ABC	<a href="#">GE60-KRR-B</a>
SKF	<a href="#">YEL 212-2F</a>
INA	<a href="#">GE60-KRR-B</a>
SNR	<a href="#">EX212G2</a>
SLB	<a href="#">UEL212</a>
FYH	<a href="#">NA212</a>
NTN	<a href="#">UEL 212 D1 W3</a>