

GE60-KRR-B-FA101 INA

Insert bearings

TYPE: Ball bearings, Radial insert bearings, With eccentric locking collar, Spherical outer ring, Seals on both side, R seal, relubrication, for high and low temperatures (-40+180)

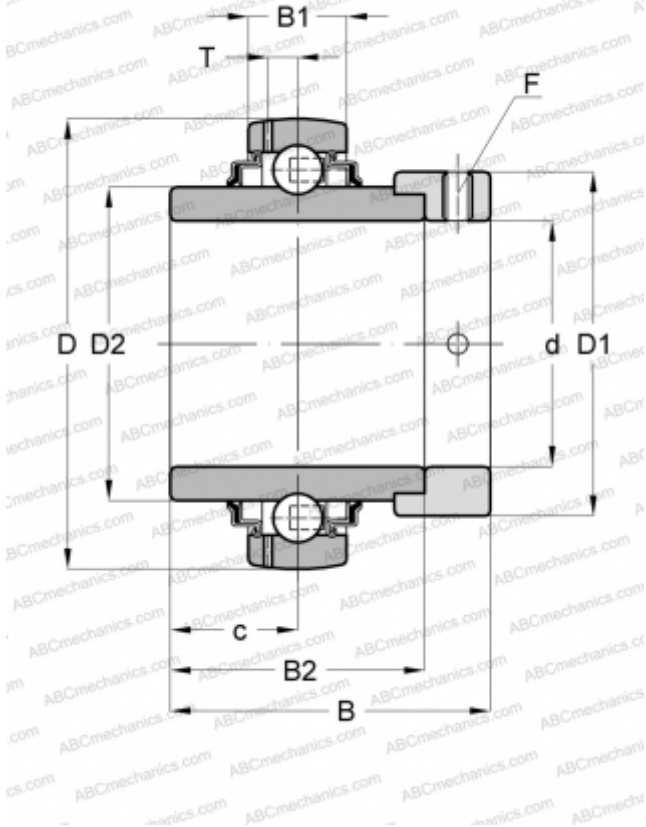

Technical specification

DIMENSIONS, MM

d	60,000
D	110,000
D1	84,000
B	77,900
B1	24,000
B2	61,900
c	31,000
T	7,200
F	5

MANUFACTURER

[INA](#)

CALCULATION DATA

Basic dynamic load rating, C	52,000 kN
Basic static load rating, Co	36,000 kN
Operating temperature min	-40 °C
Operating temperature max	180 °C

REPLACES

GE60-XL-KRR-B-FA101