

GE70-KRR-B-FA101 INA

Insert bearings

TYPE: Ball bearings, Radial insert bearings, With eccentric locking collar, Spherical outer ring, Seals on both side, R seal, relubrication, for high and low temperatures (-40+180)

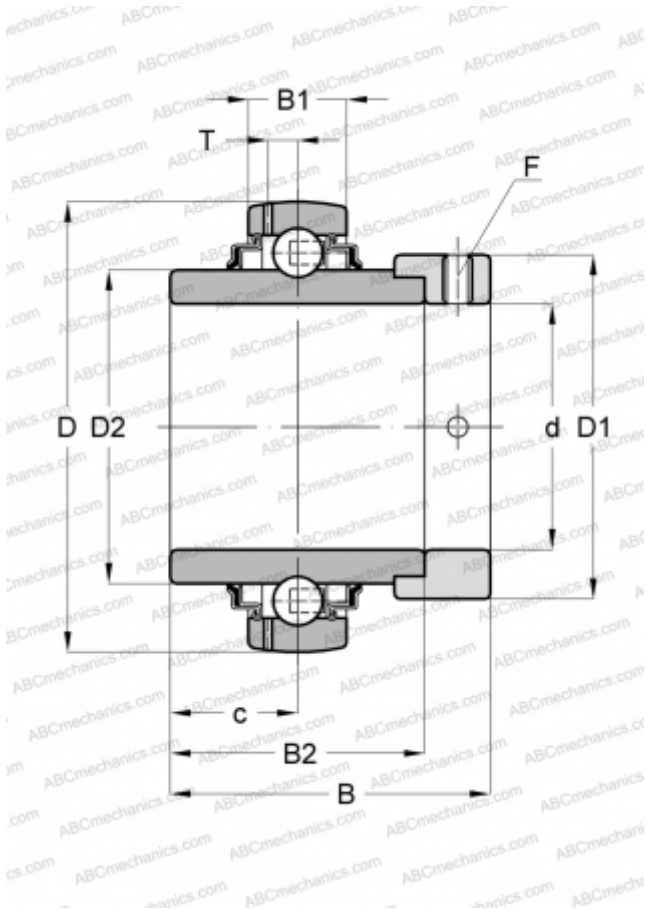

Technical specification

DIMENSIONS, MM

d	70,000
D	125,000
D1	96,000
B	66,000
B1	28,000
B2	48,500
c	21,500
T	8,900
F	6

MANUFACTURER

[INA](#)

CALCULATION DATA

Basic dynamic load rating, C	62,000 kN
Basic static load rating, Co	44,000 kN
Operating temperature min	-40 °C
Operating temperature max	180 °C

REPLACES

GE70-XL-KRR-B-FA101