

GE30-KRR-B-FA164 INA

Insert bearings

TYPE: Ball bearings, Radial insert bearings, With eccentric locking collar, Spherical outer ring, Seals on both side, R seal, relubrication, for high temperatures (to +250)

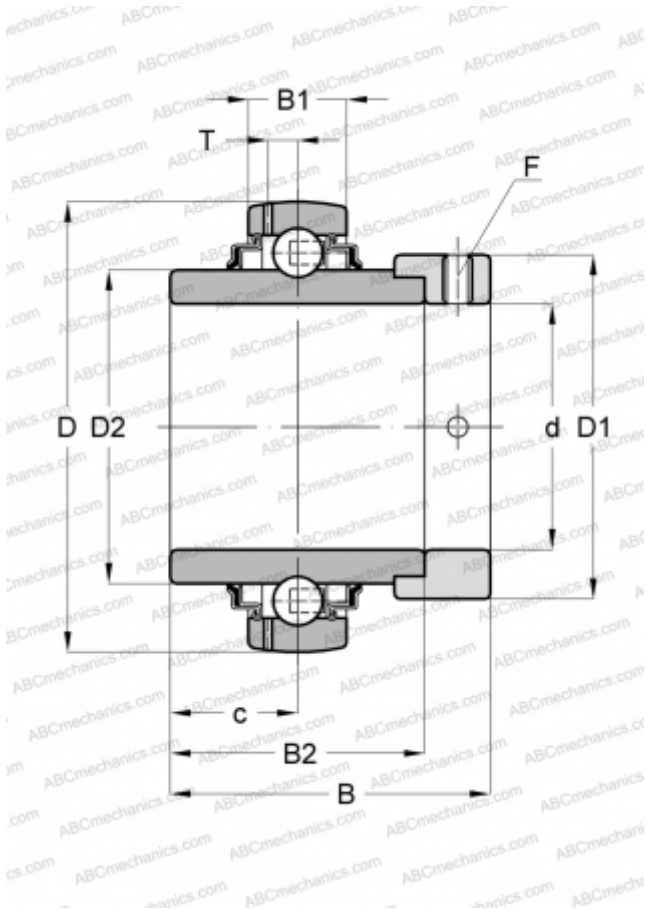

Technical specification

DIMENSIONS, MM

d	30,000
D	62,000
D1	44,000
B	48,500
B1	18,000
B2	36,500
c	18,300
T	4,700
F	4

MANUFACTURER

[INA](#)

CALCULATION DATA

Basic dynamic load rating, C	19,500 kN
Basic static load rating, Co	11,300 kN
Operating temperature min	150 °C
Operating temperature max	250 °C

REPLACES

GE30-XL-KRR-B-FA164