

GE40-KRR-B-FA164 INA

Insert bearings

TYPE: Ball bearings, Radial insert bearings, With eccentric locking collar, Spherical outer ring, Seals on both side, R seal, relubrication, for high temperatures (to +250)

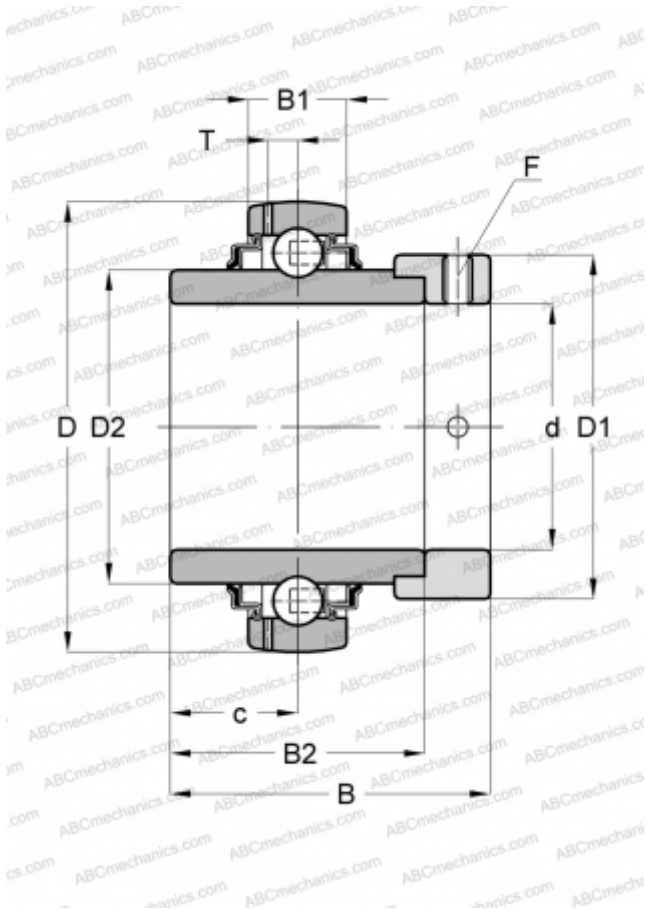

Technical specification

DIMENSIONS, MM

d	40,000
D	80,000
D1	58,000
B	56,500
B1	21,000
B2	42,900
c	21,400
T	6,400
F	5

MANUFACTURER

[INA](#)

CALCULATION DATA

Basic dynamic load rating, C	32,500 kN
Basic static load rating, Co	19,800 kN
Operating temperature min	150 °C
Operating temperature max	250 °C

REPLACES

GE40-XL-KRR-B-FA164