

GE50-KRR-B-FA164 INA

Insert bearings

TYPE: Ball bearings, Radial insert bearings, With eccentric locking collar, Spherical outer ring, Seals on both side, R seal, relubrication, for high temperatures (to +250)

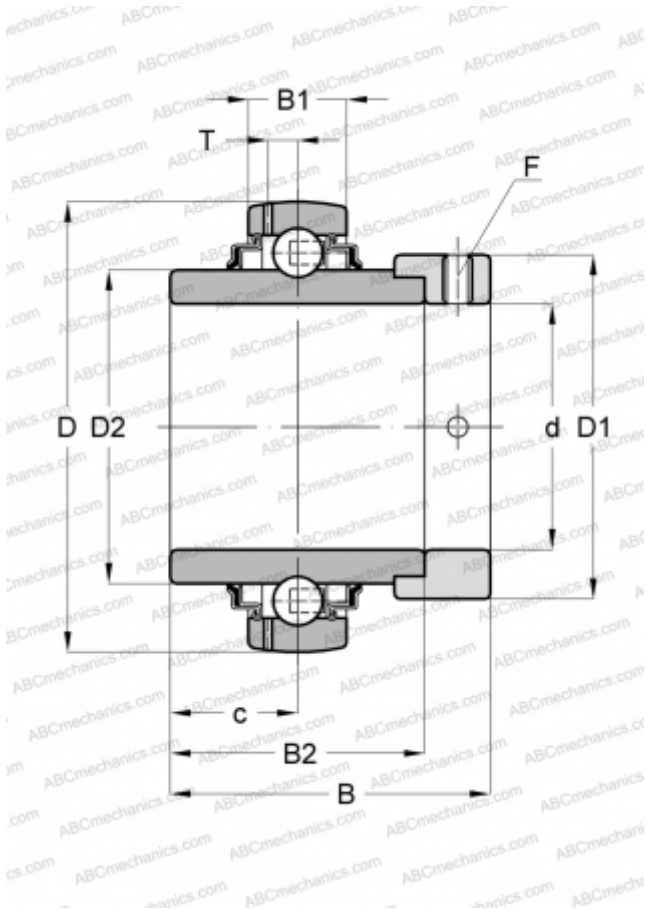

Technical specification

DIMENSIONS, MM

d	50,000
D	90,000
D1	69,000
B	62,800
B1	22,000
B2	49,200
c	24,600
T	6,900
F	5

MANUFACTURER

[INA](#)

CALCULATION DATA

Basic dynamic load rating, C	35,000 kN
Basic static load rating, Co	23,200 kN
Operating temperature min	150 °C
Operating temperature max	250 °C

REPLACES

GE50-XL-KRR-B-FA164